

CONTI® SYNCHROFLEX Polyurethane Timing Belts Overall catalog

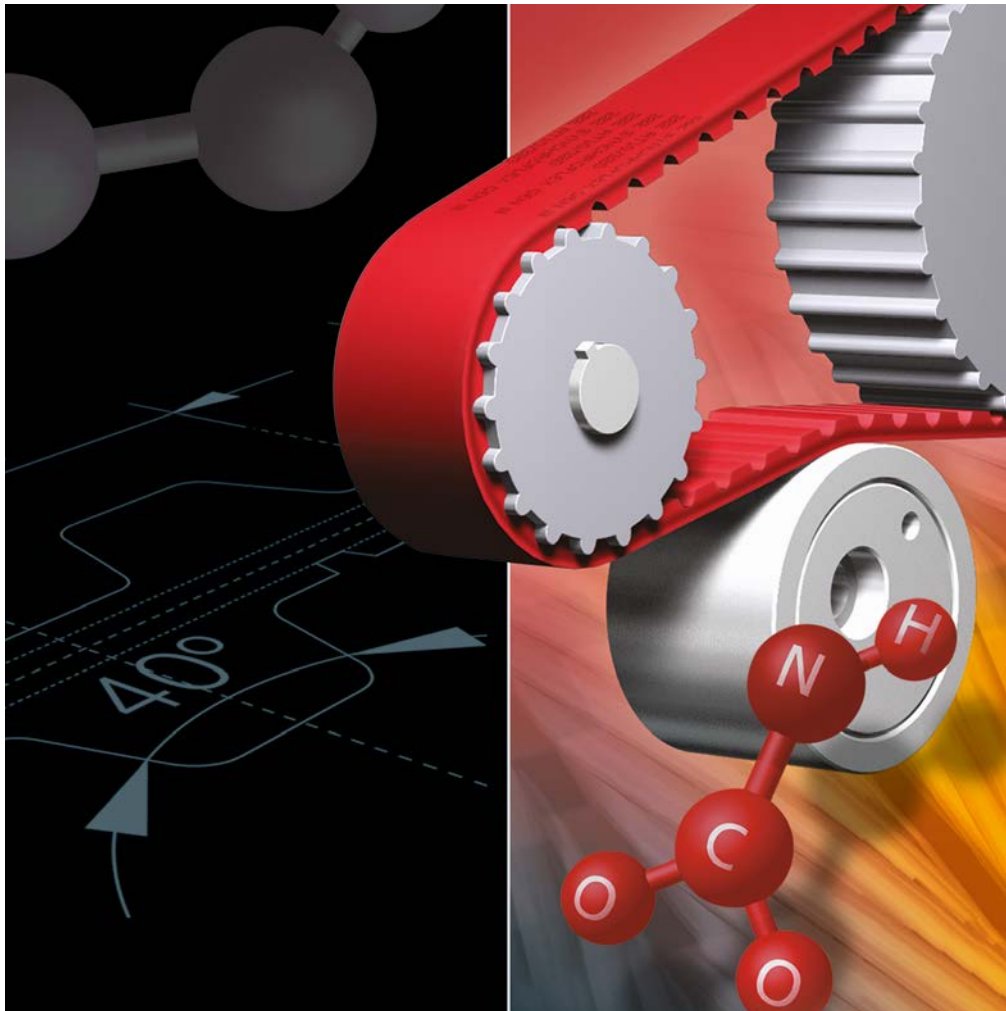

© Registered trademark of ContiTech AG



ContiTech



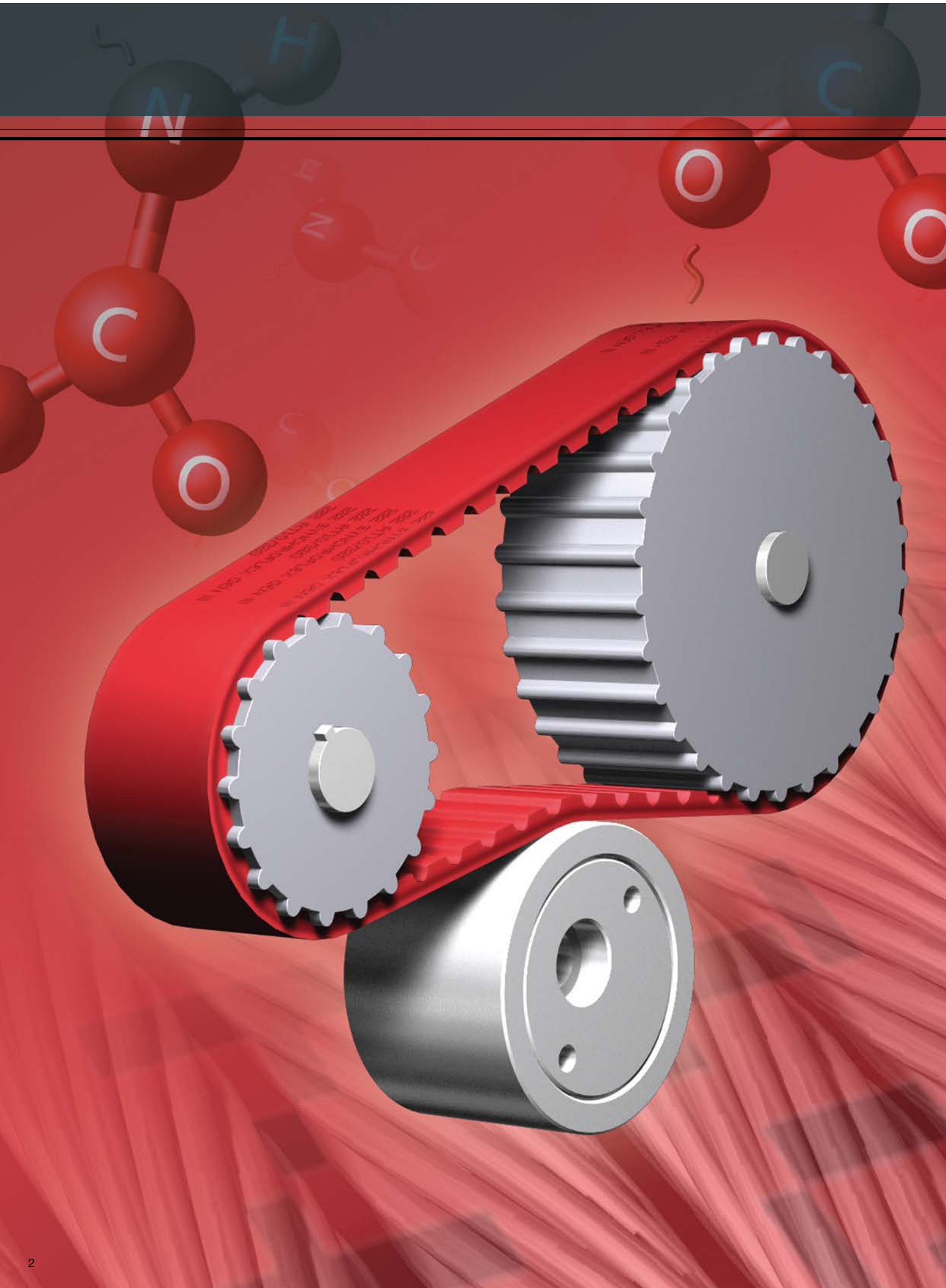

CONTI® SYNCHROFLEX Timing Belts

Advanced manufacture and high-performance materials combine for product excellence

CONTI® SYNCHROFLEX polyurethane timing belts deliver best-in-class power transmission performance thanks to the uncompromising selection of high-grade components and the superior bonding strength between the hard-wearing polyurethane shell and the constant-length galvanised steel tension members.

The highly flexible production process is particularly suitable for manufacturing double-sided belts and high accuracy profiles on the belt back. A range of specialist compounds and materials are available to enable operation at low temperatures, in clean rooms and in the food industry.



Content:

Page	General Information
4	Manufacturing process
5	Construction
6	Timing Belt Types
8	Antistatic CONTI® SYNCHROFLEX Timing Belts
9	“E” tension member
10	High-power version GEN III
12	Belt performance table
14	Tolerances
15	Mulco belt-pilot
16	Angular drives
17	Guiding belts with flanges
18	Tooth gap shapes
19	Safety factors
20	Pre-tension force
22	Basis of calculation
	AT high performance Timing Belts
28	AT 3 GEN III
30	AT 3
32	AT 5 GEN III
34	AT 5
36	AT 10 GEN III
38	AT 10
40	ATP 10 GEN III
42	ATP 10
44	ATP 15 GEN III
46	ATP 15
48	AT 20 GEN III
50	AT 20
	T standard Timing Belts
52	T 2
54	T 2,5 / T 2,5-DL
56	T 5 / T 5-DL
58	T 10 / T 10-DL
60	T 20 / T 20-DL
	Imperial Timing Belts
62	M (MXL)
	Serrated Profile Timing Belts
64	K 1 / K 1,5
	F Flat Belts
66	F/AF/BF/CF/DF
	Timing Belts with special tooth profiles
67	V (excerpts of XL, L, H)
	Special Timing Belt Versions
68	Coated timing belts
76	Integrated flights
78	Brush timing belts
80	Mechanical rework
81	List of Catalogues
83	Addresses

Manufacturing process

CONTI® SYNCHROFLEX polyurethane timing belts consist of two components – a cast polyurethane shell and a high grade steel cord tension member. The excellent bond between the two materials results in a very high power transmission capacity.

The manufacturing process – cast moulded polyurethane – combines the following advantages:

- The cast polyurethane timing belt is an exact image of the precision engineered mould. High pitch accuracy is achieved over the entire belt. The technology is particularly suitable for applications requiring high levels of angular accuracy, smooth running characteristics, high rotational speeds and long life.
- Excellent linearity with high pitch accuracy and repeatability allows the length to be optimised by adjusting the cord tension.
- The casting method combines with the capillary effect, producing an exceptionally high strength bond with the steel tension members.
- The high reproduction quality of the cast polyurethane process enables fine contoured features and smaller belt pitches to be moulded. Double-sided belts and profiled flights on the back of the belt can be moulded simultaneously.
- The process produces an effective belt width of up to 300 mm.
- Belt lengths from 55 mm to 6000 mm endless length.

CONTI® SYNCHROFLEX polyurethane timing belts are used across a very wide range of applications for the transmission of synchronous rotary motion in power transmission systems, servo and motion controls, conveyors and transfer lines. They operate in a rotational speed range of up to 20,000 rpm.

Applications include:

- office machinery
- electronic data processing equipment (EDP)
- textile machinery
- wood processing machinery
- machine tools
- printing machinery
- pumps
- compressors
- building machinery

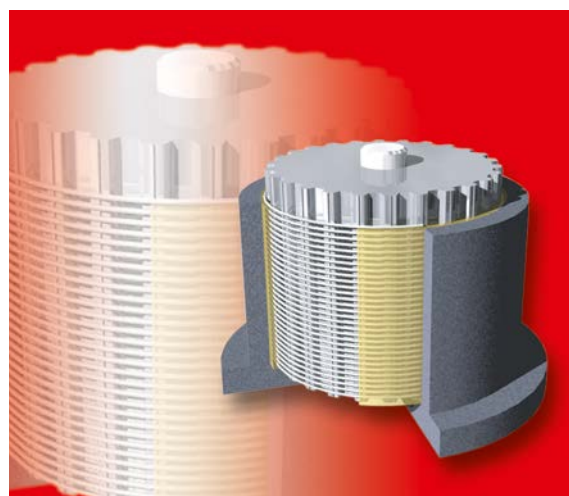
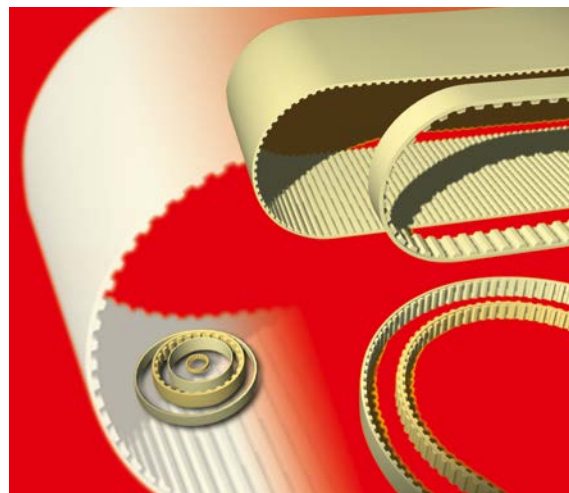

Casting mould, illustrated with a spirally wound tension member on the mould core.



Ready de-moulded timing belt sleeve, partly separated into individual belts.

Construction

CONTI® SYNCHROFLEX polyurethane timing belts are manufactured from wear resistant polyurethane and high tensile steel cord tension members. Both high quality materials combine to form the basis for dimensionally stable and highly durable polyurethane timing belts. Polyurethane timing belts have very high longitudinal stiffness and no post-elongation of the tension members is to be expected in continuous operation. Only under extreme loading conditions and as a precaution after a brief run-in, a small loss of tension may necessitate a once-only retensioning.

The timing belts are temperature resistant with ambient temperatures from -30°C to $+80^{\circ}\text{C}$. However, applications close to these temperature limits ($< -10^{\circ}\text{C}$ and $> +50^{\circ}\text{C}$), may require adapted dimensioning. For specific temperature ranges, optional belt materials are available; e.g. the CONTI® SYNCHROFLEX GEN III polyurethane timing belt range is temperature resistant up to $+100^{\circ}\text{C}$. Please contact our technical specialists for this type of application.



CONTI® SYNCHROFLEX polyurethane timing belts are manufactured using production methods that maintain very high tolerances to ensure a uniform load distribution during power transmission. They are equally suited for high torque transmission and precise positioning applications or the combination of both.

Properties:

mechanical

- positive fit, synchronous running
- constant length, no post-elongation
- low noise
- wear resistant
- low-maintenance
- highly flexible
- positional and angular accuracy
- fatigue resistant, low extension steel cord tension members
- belt speeds up to 80 ms^{-1}
- small production quantities available
- excellent power-to-weight ratio
- low pre-tension
- low bearing loads
- permits large centre distances
- permits large transmission ratios
- high degree of efficiency, max. 98%

chemical

- hydrolysis stabilized
- resistant to aging
- temperature resistant from -30°C to 80°C , note: CONTI® SYNCHROFLEX GEN III up to 100°C (see information in the text "Construction")
- tropical climate resistant
- resistant against simple oils, fats and petrol
- resistant to some acids and alkalines

For further information about the environmental resistance characteristics of CONTI® SYNCHROFLEX polyurethane timing belts please contact your Mulco sales partner.

Timing Belt Types

AT High capacity profile

Further development of the T profile resulted in the AT profile. This type of belt is characterised by the larger tooth shear strength resulting from the larger tooth volume and the stronger tension members.

Further advantages:

- favourable tooth mesh
- strengthened tension members for constant pitch
- Improved performance up to 50 % as compared to the T profile
- precise transmission of movement in conjunction with synchronous pulleys with reduced or zero backlash
- reduction of meshing impacts or shocks
- compact drive dimensions

(also available in the GEN III version)

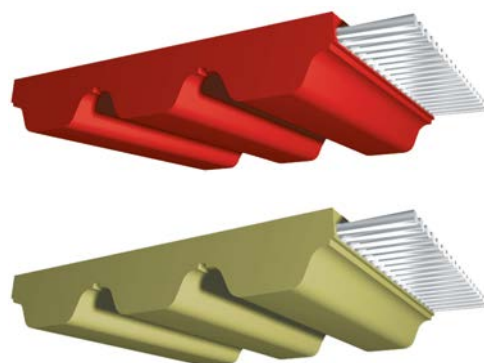

ATP High capacity profile

Further increased performance, noise reduction and extension of the belts useful life led to the development of the ATP timing belt in 1993. At the time, the main interest was focussed on the optimum tooth form. The basic concept of the new ATP profile provides the division of the trapezoidal tooth into two individual and load bearing teeth.

Performance increase up to 60 %, running noise reduced by up to 10 db(A) and an increased longevity by:

- tooth surface area increased by 70 %
- uniform load/tension distribution
- improved power dispersion
- reduced polygon effect
- small construction width
- optimised tooth mesh

(also available in the GEN III version)

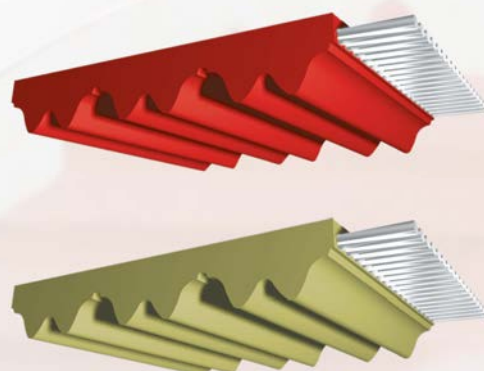

T Standard profile

The timing belt with a trapezoidal profile according to DIN 7721 is regarded as the classical standard timing belt.

Preferred use:

- for standard drive tasks
- transmission tasks with double-sided belts
- for high bending stress
- for drives with contraflexure

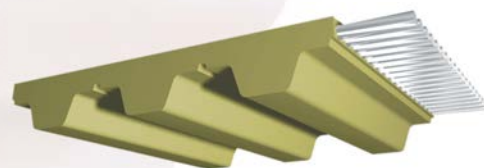

T in DL version

The DL timing belt (the belt is double-sided) is used in the power transmission and transport technology. Multiple-shaft drives with different rotational directions can be realised with this timing belt. Full load ability on both tooth sides.

**Imperial profile**

Imperial pitches according to DIN/ISO 5296 are available in the following sizes:

M (MXL)	=	2.032 mm		
XL	=	5.080 mm	L	= 9.525 mm
H	=	12.700 mm	XH	= 22.225 mm

Preferred use:

- Applications in imperial units

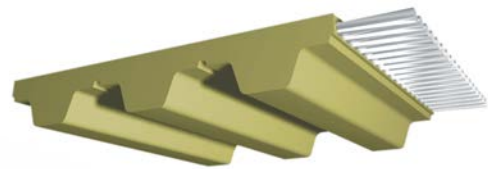
**F F Flat belts**

Preferred use:

- Friction drives (open length and endless)
- high-speed drives (CONTI® SYNCHROFLEX Belt)
- drives without synchronous transmission

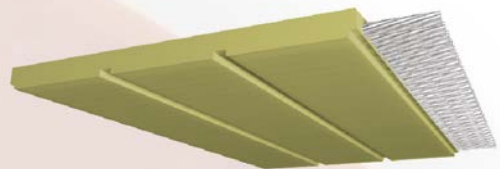
**K Serrated metric pitch profile.**

Preferred use:

- Fine mechanical technology requiring small dimensions

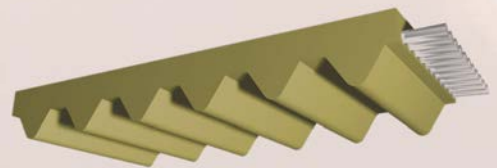
**V** The development of the PU timing belt started in 1954 with pitches other than standard.

Preferred use:

- tasks requiring special pitches
- spares

Please contact your nearest Mulco distributor to know more about our entire range of V-type belts.

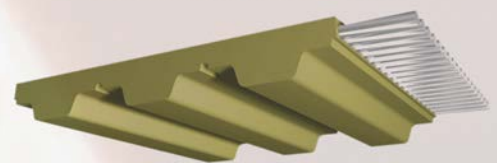

Antistatic CONTI® SYNCHROFLEX Timing Belts

Characteristics of CONTI® SYNCHROFLEX Antistatic Timing Belts

The antistatic properties of CONTI® SYNCHROFLEX polyurethane timing belts are achieved by:

1. antistatic coating

A post-process application of an electrically conductive coating on all sides of the belts with or without textile facing

2. antistatic polyurethane mixture

A special conductive polyurethane mixture (max. belt length to 700 mm)

Other lengths on request.

Colour of antistatic timing belts: black.

Application / Use

Antistatic CONTI® SYNCHROFLEX polyurethane timing belts are used where electrostatic discharge (ESD) is not desired or is prohibited, e.g. for the transport of electronic components, for drives and/or conveying equipment in an inflammable or explosive environment.

Electrostatic charges

The build up of static electricity, due to the continual separation of two contact surfaces, can be expected where timing belts are involved, e.g. between pulley and timing belt. This static electric charge can be considerable and may increase the danger of ignition at the moment of discharge. The value of the static electric charge is dependent on the materials used for the timing belt, synchronous pulleys, tension rollers and/or support rollers. The risk of ESD rises as the belt speed, belt tension and the contact surface width increase.

Antistatic properties

Antistatic CONTI® SYNCHROFLEX polyurethane timing belts consistently avoid the formation of static electric charges.

Quality assurance

Conductivity is measured using test equipment meeting ISO 9563 requirements. Upon request, the wear resistance of the antistatic layer can be checked on test timing belts with an antistatic facing. Due to the fact that extended operation will result in probable surface wear, the conductivity of the antistatic timing belts may deteriorate and regular checks of the resistance values are essential. When belts are to be used in environments with a high likelihood of explosion, please contact our technical specialists for advice.

Order example

CONTI® SYNCHROFLEX Timing Belt 25 T 5 / 630 EL-PU antistatic coated

For available lengths, please contact your Mulco sales partner.



“E” Tension Member

Highly flexible tension members – the “E” steel cord tension member

The smaller the diameter of each single wire, the more flexible the overall tension member is! This relationship led us to develop CONTI® SYNCHROFLEX polyurethane timing belts with “E” tension members.

The cross sectional area of the “E” tension member comprises several strands of smaller diameter wires, each with excellent bending fatigue characteristics. With much improved overall flexibility CONTI® SYNCHROFLEX polyurethane timing belts are particularly suited to smaller diameter pulleys and tension rollers; the minimum number of teeth and/or minimum diameter of the pulleys can be reduced by up to 30% compared with standard tension members. Timing belts with “E” tension members are recommended for multi-shaft drive applications with frequent reverse bending.

Summary:

- smaller diameter individual wires in the steel cord
- higher dynamic capabilities
- extremely high bonding and bending fatigue strength
- smaller pulley and tension roller diameters
- runs on standard diameter timing pulleys.

For applications under extreme conditions, please contact your Mulco sales partner.

Application information:

Steel cord tension members encapsulated in polyurethane:

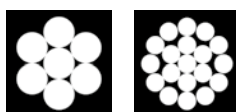

The smaller the diameter of the individual wire, the more flexible the whole timing belt.

Available versions:

- for the pitches AT 3 (standard), AT 5 (Gen III standard), AT 10, ATP10, T 5, T 10, T 20
- all standard belt lengths for the chosen pitch
- all standard pulley sizes for the chosen pitch
- all calculations as per the standard belt chosen

Timing belts with “E” tension members, minimum numbers of teeth:

Drive Type			AT 3 (Standard)	AT 5 (GEN III, Standard)	AT 10 ATP 10	T 5	T 10	T 20
without contraflexure 	Timing pulley	z_{\min}	15	12	12	10	10	12
	Tension roller (smooth), running on teeth	d_{\min} [mm]	20	18	50	18	50	80
with contraflexure 	Timing pulley	z_{\min}	20	20	20	12	15	20
	Tension roller (smooth), running on the back of the belt	d_{\min} [mm]	20	50	80	18	50	120

High-power version GEN III

CONTI® SYNCHROFLEX Timing Belt (SFX) AT GEN III / ATP GEN III

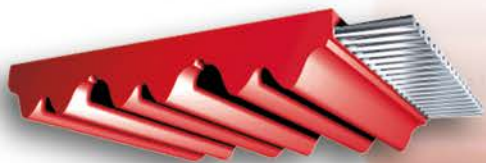

A powerful basis

The combination of high tensile steel cord tension members and wear resistant polyurethane forms the basis for dimensionally stable and extremely durable high-performance timing belts. A convincing technology with excellent product features that include:

- constant length, no post-elongation
- high dimensional stability
- high-torque transmission
- quiet running
- maintenance-free
- lubrication-free
- highly chemical resistant and mechanically durable

Each generation is different.

GEN III is better!

It was worth its while to focus on further developing the power drives of the AT and ATP range CONTI® SYNCHROFLEX polyurethane timing belts because the new GEN III generation excels in a 25% increase in power transmission compared with the AT/ ATP standard. Another economic bonus: all CONTI® SYNCHROFLEX GEN III polyurethane timing belts support the use of standard AT/ATP pulleys.

Mulco partners everywhere agree that advancement is synonymous to providing solutions for every product at a level of sophistication down to the smallest detail. A bifilar tension member arrangement and a higher packing density translates this into the CONTI® SYNCHROFLEX GEN III polyurethane timing belt for the AT and ATP ranges.

The high-performance polyurethane designed for dedicated use with the CONTI® SYNCHROFLEX GEN III polyurethane timing belts yields greatly improved benchmark results compared with the standard. One of the benefits is that its increased hardness allows line engineers to count on a larger number of load-carrying teeth.

CONTI® SYNCHROFLEX GEN III – with up to 25% greater power transmission compared with the AT / ATP standard:

- increased tensile force F_{zul} to max. +45% due to closer wound cords
- Increased power transmission F_{spec} +25%
- redesigned bifilar steel (S and Z) cord balance for better tracking
- reduced flange friction
- lower running noise with narrower belt width for equal performance
- longer life
- load bearing teeth force distribution – increased by up to 30%
- temperature range up to +100° C
(For performance values close to the range limit, please contact your Mulco sales partner.)

Two-filament tension member arrangement

New high performance polyurethane

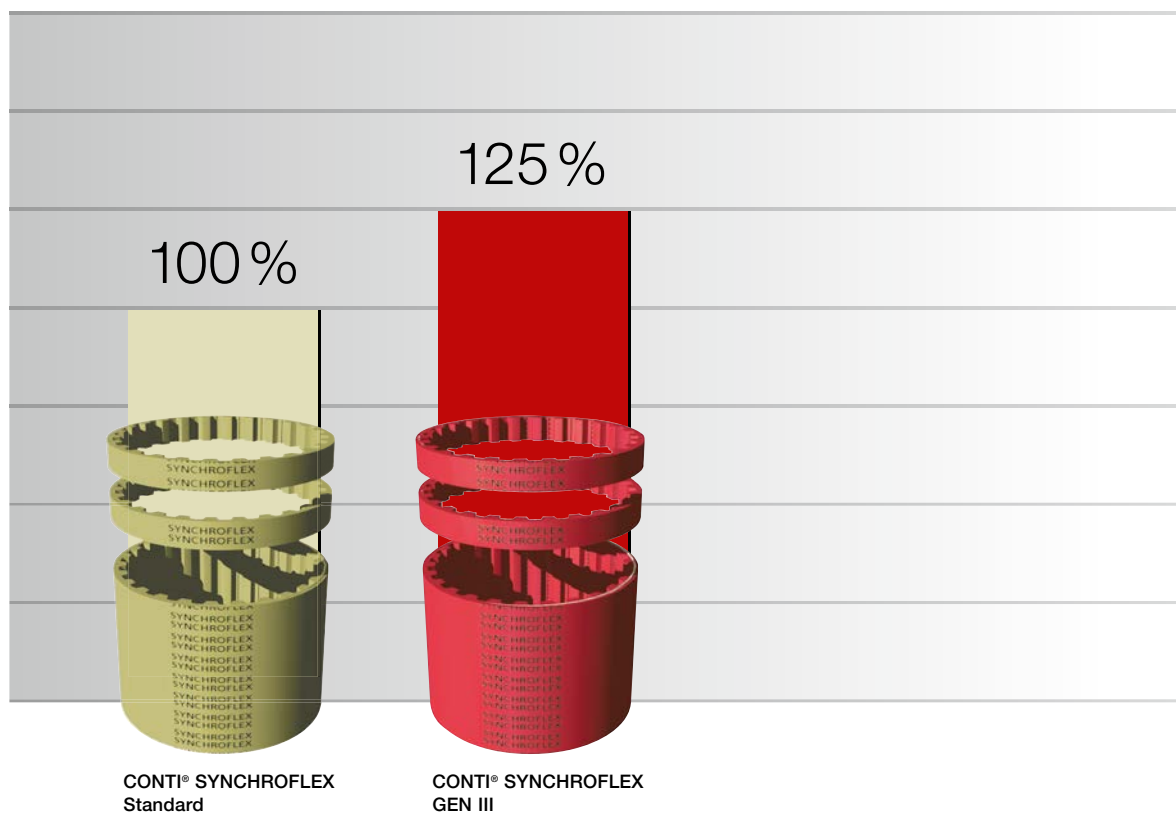
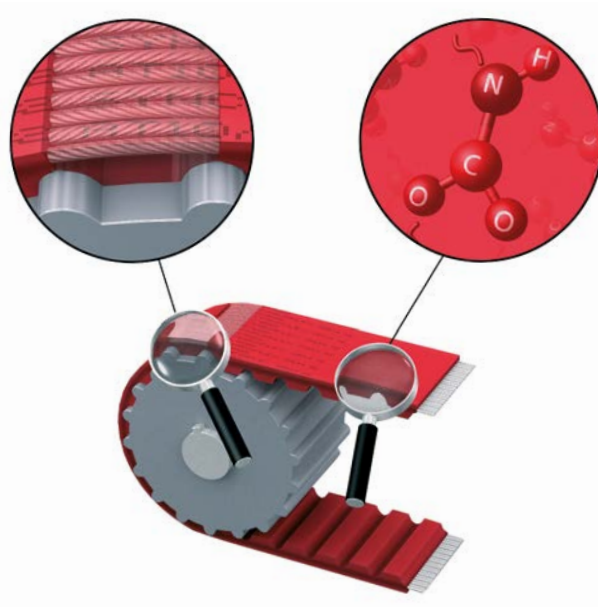

Belt performance table

Belt performance table

AT 3 GEN III

Power transmission: ≤ 6 kW
 Rotational speed: approx. 20.000 min⁻¹
 Peripheral speed: approx. 80 ms⁻¹
 Timing pulleys: from z=15

Applications (Example): small power drives,
 Handling technology

AT 3

Power transmission: ≤ 5 kW
 Rotational speed: approx. 20.000 min⁻¹
 Peripheral speed: approx. 80 ms⁻¹
 Timing pulleys: from z=15

Applications (Example): small power drives,
 Handling technology

AT 5 GEN III

Power transmission: ≤ 18 kW
 Rotational speed: approx. 10.000 min⁻¹
 Peripheral speed: approx. 80 ms⁻¹
 Timing pulleys: from z=15

Applications (Example): Machine tools, Pumps,
 Textile machinery

AT 5

Power transmission: ≤ 15 kW
 Rotational speed: approx. 10.000 min⁻¹
 Peripheral speed: approx. 80 ms⁻¹
 Timing pulleys: from z=15

Applications (Example): Machine tools, Pumps,
 Textile machinery

AT 10 GEN III

Power transmission: ≤ 87 kW
 Rotational speed: approx. 10.000 min⁻¹
 Peripheral speed: approx. 60 ms⁻¹
 Timing pulleys: from z=15

Applications (Example): Construction machines,
 Pumps, Paper-making
 machines, Compressors
 compactors, Textile machin-
 ery, Roller-table drives

AT 10

Power transmission: ≤ 70 kW
 Rotational speed: approx. 10.000 min⁻¹
 Peripheral speed: approx. 60 ms⁻¹
 Timing pulleys: from z=15

Applications (Example): Construction machines,
 Pumps, Paper-making
 machines, Compressors
 compactors, Textile machin-
 ery, Roller-table drives

ATP 10 GEN III

Power transmission: ≤ 150 kW
 Rotational speed: approx. 10.000 min⁻¹
 Peripheral speed: approx. 60 ms⁻¹
 Timing pulleys: from z=15

Applications (Example): Machine tools, Textile
 machinery, Power drives

ATP 10

Power transmission: ≤ 100 kW
 Rotational speed: approx. 10.000 min⁻¹
 Peripheral speed: approx. 60 ms⁻¹
 Timing pulleys: from z=15

Applications (Example): Sanding machinery,
 Power drives,
 Machine tools

ATP 15 GEN III

Power transmission: possible beyond 220 kW
 Rotational speed: approx. 10.000 min⁻¹
 Peripheral speed: approx. 50 ms⁻¹
 Timing pulleys: from z=20

Applications (Example): Textile machinery,
 Machine tools,
 High power drives

ATP 15

Power transmission: possible beyond 200 kW
 Rotational speed: approx. 10.000 min⁻¹
 Peripheral speed: approx. 50 ms⁻¹
 Timing pulleys: from z=20

Applications (Example): Power drives,
 Machine tools

AT 20 GEN III

Power transmission: possible beyond 250 kW
 Rotational speed: approx. 6.500 min⁻¹
 Peripheral speed: approx. 40 ms⁻¹
 Timing pulleys: from z=18

Applications (Example): Heavy-duty drives, Textile
 machinery, Printing machine,
 Machine tools

AT 20

Power transmission: possible beyond 200 kW
 Rotational speed: approx. 6.500 min⁻¹
 Peripheral speed: approx. 40 ms⁻¹
 Timing pulleys: from z=18

Applications (Example): Heavy-duty drives,
 Textile machinery,
 Printing Machine,
 Machine tools

K 1,5; T 2; M; T 2,5

Power transmission: ≤ 0,5 kW
 Rotational speed: approx. 20.000 min⁻¹
 Peripheral speed: approx. 80 ms⁻¹
 Timing pulleys: from z=10

Applications (Example): Precision machine drives,
 Film camera drives,
 Positioning drives

T 5

Power transmission: ≤ 5 kW
 Rotational speed: approx. 10.000 min⁻¹
 Peripheral speed: approx. 80 ms⁻¹
 Timing pulleys: from z=10

Applications (Example): Office machinery,
 Home appliances,
 Positioning and
 regulating drives

T 10

Power transmission: ≤ 30 kW
 Rotational speed: approx. 10.000 min⁻¹
 Peripheral speed: approx. 60 ms⁻¹
 Timing pulleys: from z=12

Applications (Example): Machine tools,
 Main and subsidiary drives,
 Textile machinery,
 Printing machinery

T 20

Power transmission: up to approx. 100 kW
 Rotational speed: approx. 6.500 min⁻¹
 Peripheral speed: approx. 40 ms⁻¹
 Timing pulleys: from z=15

Applications (Example): Heavy Construction machines,
 Paper-making machines,
 Pumps, Compressors
 compactors, Textile machinery

Remark:

Special timing belt designs allow the rpm and peripheral speed parameters to be increased.

Tolerances

CONTI® SYNCHROFLEX Timing Belts Tolerances

Length tolerances for standard CONTI® SYNCHROFLEX Polyurethane Timing Belts

Belt length measurement is carried out to
DIN 7721, in relation to the centre distance.

Belt length	Length tolerance in relation to centre distance
up to 320 mm	±0,15 mm
320 – 630 mm	±0,18 mm
630 – 1000 mm	±0,25 mm
1000 – 1960 mm	±0,40 mm
1960 – 3500 mm	±0,50 mm
3500 – 4500 mm	±0,80 mm
4500 – 6000 mm	±1,20 mm

Width tolerances for standard CONTI® SYNCHROFLEX Polyurethane Timing Belts

Type / group	up to 50 mm	50 – 100 mm	over 100 mm in % der Belt width
K 1	±0,3 mm	±0,5 mm	±0,5 %
K 1,5	±0,3 mm	±0,5 mm	±0,5 %
T 2	±0,3 mm	±0,5 mm	±0,5 %
M (MXL)	±0,3 mm	±0,5 mm	±0,5 %
T 2,5	±0,3 mm	±0,5 mm	±0,5 %
T 5	±0,3 mm	±0,5 mm	±0,5 %
T 5-DL	±0,3 mm	±0,5 mm	±0,5 %
T 10	±0,5 mm	±0,5 mm	±0,5 %
T 10-DL	±0,5 mm	±0,5 mm	±0,5 %
T 20	±1,0 mm	±1,0 mm	±1,0 %
T 20-DL	±1,0 mm	±1,0 mm	±1,0 %
AT 3	±0,3 mm	±0,5 mm	±0,5 %
AT 5	±0,5 mm	±0,5 mm	±0,5 %
AT 10	±1,0 mm	±1,0 mm	±1,0 %
ATP 10/ATP 15	±1,0 mm	±1,0 mm	±1,0 %
AT 20	±1,0 mm	±1,0 mm	±1,0 %

Please note:

Tolerance for special tension members
upon request.

Mulco b@lt-pilot

Your direct road to perfect design solutions

Mulco belt-pilot – online support at www.mulco.net

Let others talk about being close to the customer, we as the market leading provider of polyurethane timing belts actually live by the idea. Mulco-Europe EWIV's secret of success has always been largely due to advising our customers before they enter the design stage. Mulco belt-pilot is taking our customer dedication a critical step further ahead. Our interactive Internet service offering enables you to calculate your personal design solutions online. Whatever field of technology you are interested in - power transmission, linear, transport or components - start Mulco belt-pilot at www.mulco.net for 24/7 access to the actual product information, CAD downloads and calculations you need.

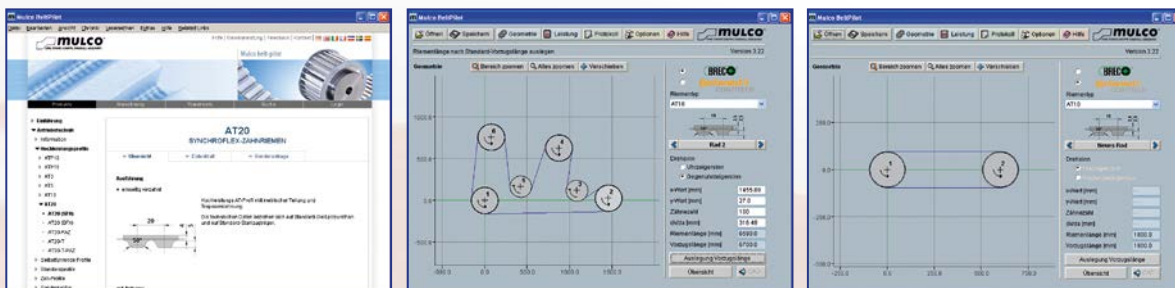

Mulco b@lt-pilot

Many benefits.

- ▶ Interactive service offering with video-based e-learning option
- ▶ Extensive product databases
- ▶ Free use of CAD downloads
- ▶ Import the CAD drawings into your CAD system
- ▶ Calculate timing belts, pulleys and components
- ▶ Email inquiries supported



Angular drives

CONTI® SYNCHROFLEX timing belts can be applied as angular drives. Take into consideration that the timing belt can only be crossed (twisted). Eliminates the run-off effect.

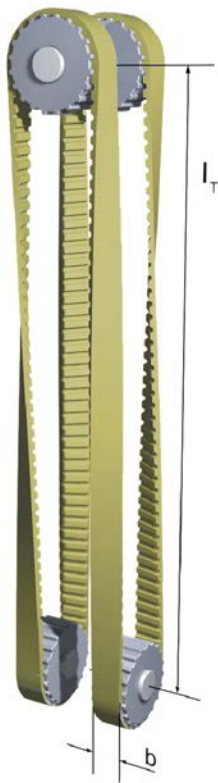

Angular drive with 2 axes

$l_T/b \geq 20$
 b = Belt width
 l_T = Span length

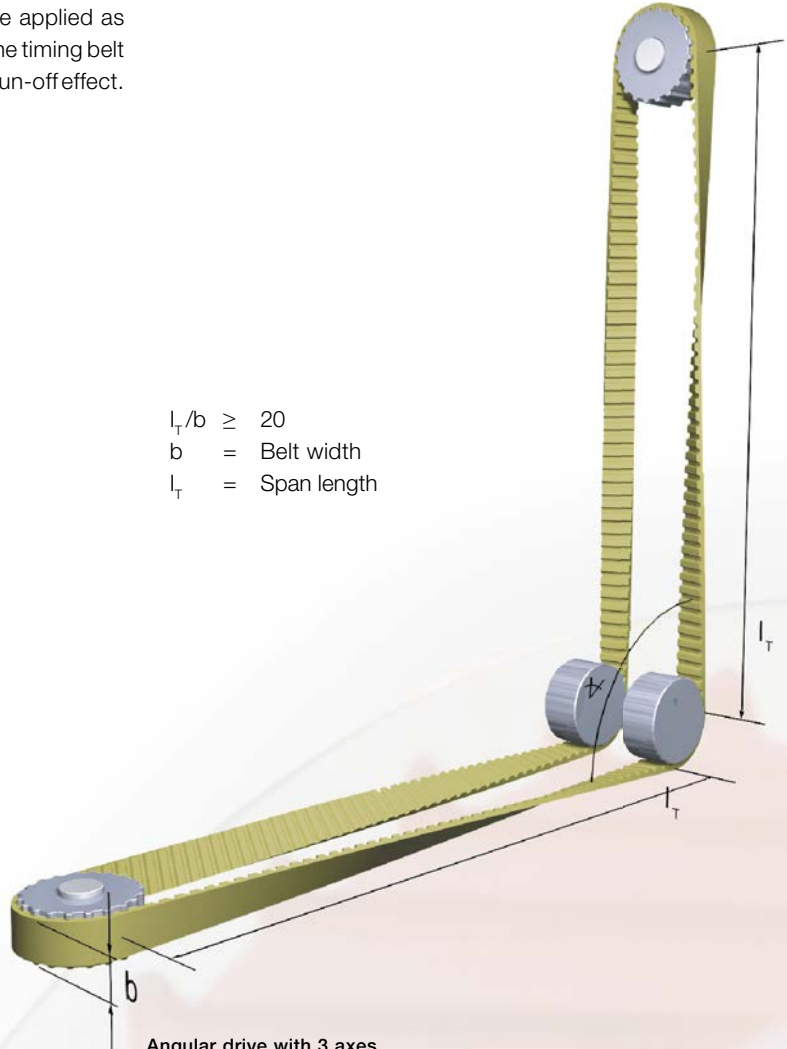

Angular drive with 3 axes

With crossed timing belt applications the outer tension members suffer a higher elongation than the inner ones. Due to the larger elongation in the edge zone the permitted proportional circumferential force for the belt in the tension members is reduced.

No power reductions or special measures are necessary at a ratio of $l_T / b \geq 20$.

At a required ratio of $l_T / b < 20$ please contact our technical department for advice.

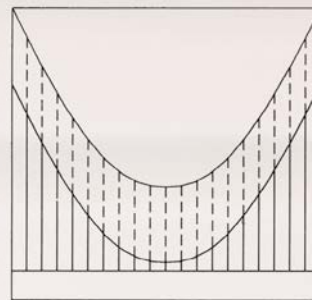

F_{zul} admissible tensile force
 F_U The remaining peripheral force
 F_S Tensile force due to crossing

Guiding belts with flanges

Timing belts must be guided to eliminate the lateral run-off effect. This is normally done by flanges. Minimum lateral forces and low frictional losses can be resulted by the optimum arrangement of the belt guidance.

For this purpose, the following possibilities are available:

- Timing belt guidance downstream of a large free span length (infeed length (a) should not be less than 5 times belt width)
- Guidance at the drive pulley (preferable for two shaft drives with short centre distance)
- Guide for low-transmission pulleys (preferably for multiple-shaft drives)
- Guidance on the tension rollers
 - Tension roller arrangement in the slack span side
 - With arrangement on the belt back side: consider minimum diameter with contraflexure
 - With arrangement on the belt toothed side: Length of arc of contact, min. 3 teeth
 - with changing rotational directions preferable in the span length centre
 - Condition: Minimum span length (a) between tension roller and pulley should not be less than 5 times belt width
- Ensure high axis parallelity and flush alignment of all pulleys to achieve optimum guiding features.
- For cost reasons it is possible to fit flanges also to the smaller pulley after taking the functional reliability into consideration.

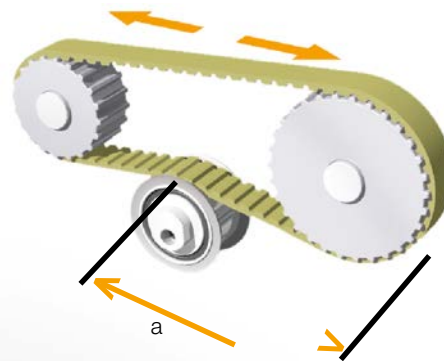

The application of CONTI® SYNCHROFLEX polyurethane timing belts in two-filament arrangement is the ideal prerequisite for an optimum belt guidance.

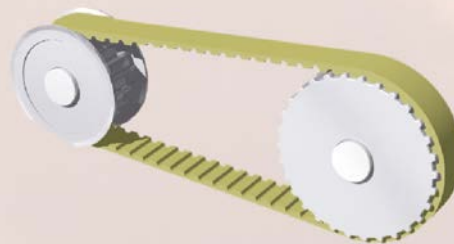

Tooth gap shapes

Timing belts are positive fitted drive elements. They work slippage-free with the respective synchronising pulleys. CONTI® SYNCHROFLEX timing belt drives can be optimised additionally for a movement transmission with a low flank backlash.

For some profiles and pitches, the SE or zero gap can be used for especially high accuracy drives. Please contact us for technical advice.

- Prerequisites for the application:
 - Pitch matching between timing belts and pulley.
- Influencing factors of the pitch matching:
 - Pre-tension force
 - No. of teeth in mesh (z_g)
 - Load rate (rotational speed, dynamic behaviour...)
 - Manufacturing tolerances

Tooth gap shapes

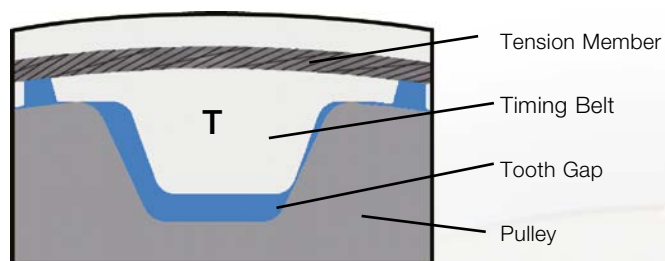

Normal Backlash
Tooth Gap

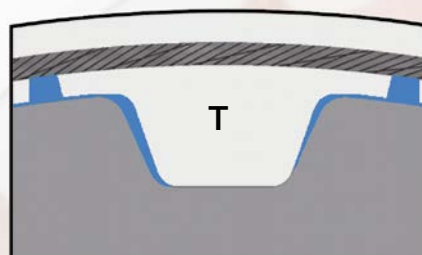

Reduced Backlash
"SE" Tooth Gap

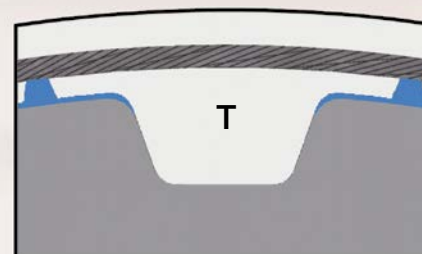

Zero Backlash
"0" Tooth Gap

Safety factors

The width of a timing belt is correct when the permissible values for tooth shear strength, tension cord strength and flexibility are not exceeded under unfavourable operating conditions. In our catalogue, load limits are stated which have been reliably proven and confirmed by bench tests and results obtained in practice. A safety factor is only required for drives with transmission into higher speed.

It is important, that the unfavourable load types occurring in the drive are known resp. correctly estimated by the engineer. With a positive fit transmission, even short-period overloads act via the timing belt being the drive member. Some instructions to this issue:

Rated operation

Design timing belts for the operating condition of the rated load. The rated load is the operating condition at which the drive should transmit the torque or the power at rated speeds under normal conditions.

Start-up characteristics

a) Drive side: The max. torque of the drive machine under start-up conditions is to be taken into consideration. The start-up torque, e.g. for three-phase squirrel cage motors amounts to 2 to 2.5 times the rated value.

b) On the drive side: If necessary, „initial torques“ affective to the drive part timing belt are to be taken into consideration under start-up characteristics.

Check load case a) or b) with rotational speed $n=0$.

Braking

It might have to be defined whether braking leads to loads which fully act via the timing belt and possibly exceed the type of load produced by the rated operation or the start-up characteristics. During braking a possible torque reversal should be taken into consideration.

Unevennesses (load variations, shock loads)

In addition to the rated load, superimposed vibration and shock loads could act on the timing belt as the transmission member. For the illustrated example, increase the calculated belt width by the factor of 1.3.

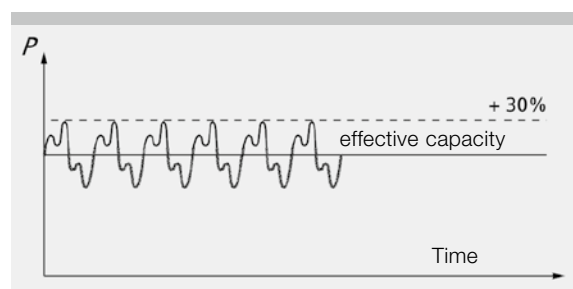

Moments of inertia

Moments of inertia and/or centrifugal masses in the drives generally create a uniform running behaviour. Depending on the acceleration and deceleration characteristic it has to be differentiated and checked whether the moments of inertia create an additional load on the timing belt.

Step-up transmission

The following safety factors are to be applied for step-up transmissions:

$i = 0,66$ up to $1,00$	$S = 1,1$
$i = 0,40$ up to $0,66$	$S = 1,2$
$i < 0,40$	$S = 1,3$

During braking a torque reversal may occur which would change a reduction ration into a step-up drive.

Pre-tension force

Pre-tension force

Pre-tension is intended to guarantee a minimum tensioning force at the slack span side to ensure smooth tooth meshing into the driven pulley.

Generally, the pre-tension should only be set as high as necessary. The necessary pre-tension force of the spans F_v depends on the max. peripheral force F_u , the belt length L_B (number of teeth Z_B) and the drive configuration.

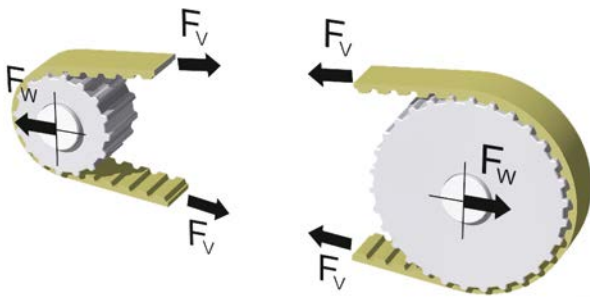

The recommendations shown in the table refer to the pre-tension force setting per span.

Drive configuration	Pre-tension force of each individual span
Two-shaft drive	
$Z_B < 60$	$F_v = 1/3 F_u$
$60 \leq Z_B < 150$	$F_v = 1/2 F_u$
$Z_B > 150$	$F_v = 2/3 F_u$
Multiple-shaft drive	
$l_{Load\ span} \leq l_{Slack\ span}$	$F_v = F_u$
$l_{Load\ span} > l_{Slack\ span}$	$F_v > F_u$
Linear drive	$F_v \geq F_u$

In every case, the tension cord strength is the top limit of the span load. Take into consideration that especially with multiple-shaft and linear drives, an addition of the pre-tension force and the peripheral force in relation to the load span force is to be expected.

Influencing factors

Belt stiffness

Friction forces created by the interaction of the tooth mesh (especially at the slack span) intensify the span forces, which in turn increase the degree of elongation. This influence may lead to the slack span tooth mesh butting against the driven pulley, thereby causing the belt to jump.

Elongation being directly depending on the belt stiffness, the high stiffness of the steel cord tension members permits a comparably low pre-tension.

Peripheral force

The peripheral force acts in proportion to the elongation of the load span, i.e. excessive slackening of the slack span can be counter-acted by a pre-tension matched to the peripheral force.

Belt length

Belt elongation resulting from the effect of the peripheral force and the friction forces is also approximately in proportion to the belt length. Therefore, the tendency of running up or jumping is considerably influenced by the belt length. Even under high peripheral forces with the resulting friction forces, a very short timing belt will elongate to only a small degree, so that even when subject to low pre-tension forces there will be no danger of running up or jumping of teeth. On the contrary, with short timing belts peripheral deviations of the pulleys could cause heavy pre-tension fluctuations and, as a result, extreme peak values.

Proportion of the span lengths

Especially with multiple-shaft drives the load span is often markedly longer than the slack span side. For this reason, a slight elongation of the load span results in a very unfavourable slack on the span side. Therefore, the pre-tension force of spans of such ratios should be higher than the peripheral force.

Precise transmission of movement

There is a high transmission accuracy possible in the reverse operation with CONTI® SYNCHROFLEX timing belts, when the span pre-tension forces are selected in the same size of the peripheral force.

Consequences of faulty pre-tension setting:

too low pre-tension

- the teeth of the slack span side run up on or override the teeth of the driven pulley
- Wear on the faces caused by the friction force during meshing
- Forced breakage by excessive elongation due to full overriding

excessive pre-tension

- high bearing load of the shafts
- Reduction of the transmittable power
- Wear and tear at the belt tooth

Measuring with frequency measuring meter

The intrinsic frequency of a vibrating belt span can be measured by means of various Mulco belt tension measuring meters. The pre-tension force of the span can be calculated from the measured intrinsic frequency:

$$F_V = 4 \cdot m \cdot l_T^2 \cdot f^2$$

The corresponding intrinsic frequency can be calculated, if the pre-tension is preset:

$$f = \sqrt{\frac{F_V}{4 \cdot m \cdot l_T^2}}$$

- f: Frequency of the variations in Hz
 m: Mass of the belt per meter length in kg/m
 l_T: drum span length subject to vibration in m
 F_V: Span force in N

Please contact your Mulco partner for the various measuring meters (see page 16).

General informations

Design

- In the transmission configuration, design at least one adjustable axis, plan one adjustable tension roller (not spring-loaded) for fix centre distances
- the bearing has to be absolutely rigid
- Note the importance of a parallel run and flush alignment of the timing pulleys

Transport/storing

- Upon receipt, unpack the timing belt immediately and store in circular position (CONTI® SYNCHROFLEX timing belts) in a dry place at room temperature
- Do not bend

Mounting

- Fit timing belts on the pulleys when slack without exerting any force
- Exert no force when fitting with fixed centre distances (CONTI® SYNCHROFLEX timing belts) if necessary, fit together with timing pulleys
- Apply pre-tensioning force according to the chapter „Pre-tension“
- secure adjustable axis against slippage
- Do not clamp the timing belt between the flanges

Operation

- Protect the drives against dust, dirt, hot surrounding media as well as acids and alkalis
- Take into consideration the ambient temperatures (see characteristics of polyurethane timing belts)

Basis of calculation

Providing the following conditions of tooth strength (1st), tension member tensile strength (2nd) and flexibility (3rd)

are met, then a maintenance-free timing belt operation can be expected.

1. Tooth shear strength

specific tooth shear strength

Force distribution

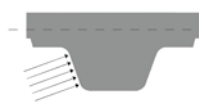
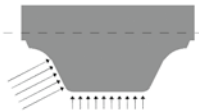
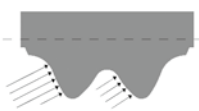

ATP

AT

T

Load distribution

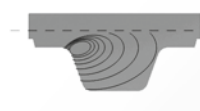
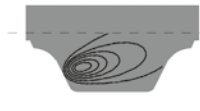
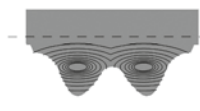

The specific tooth shear strength depends on the rotational speed. The maximum specific tooth shear strength is the limit load the belt tooth can bear in continuous operation. The values are stated in tables for each timing belt type. The timing belt drive is correctly designed, when not exceeding the admissible tooth shear strength. Generally, a special safety factor is not necessary, see chapter „Safety factors“.

The high specific tooth shear strength of the ATP profile, for example, is achieved by the optimised force and load distribution. The effective force is distributed to two tooth faces.

The working loads can be distributed more effectively with more belt teeth meshing in the pulley.

Due to the high pitch accuracy of CONTI® SYNCHRO-FLEX timing belts, generally, it can be calculated with 12 belt teeth in mesh, unless there are less than that number actually in mesh.

2. Tension member strength

Admissible tensile stress on the belt's cross-section

The timing belt is designed correctly, when the maximum admissible tensile force in the steel cord tension members is not exceeded under operation conditions. The table values for F_{zul} refer to the constant loading.

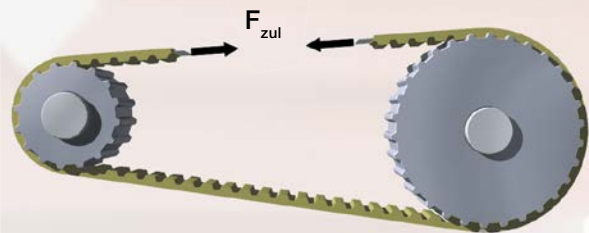

3. Flexibility

Minimum number of teeth, minimum diameter

The recommended minimum number of teeth and/or the minimum diameter for a malfunction-free operation depends on the selected belt type. Take especially into consideration that the minimum number of teeth and/or the minimum diameter is higher when using a belt arrangement „with contraflexure“ (e. g. due to a tension roller).



Drive layout without contraflexure

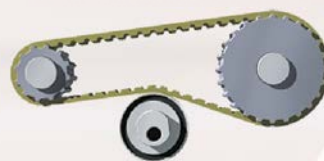

Drive layout with contraflexure

Calculation example

Calculation example

Terms, definitions

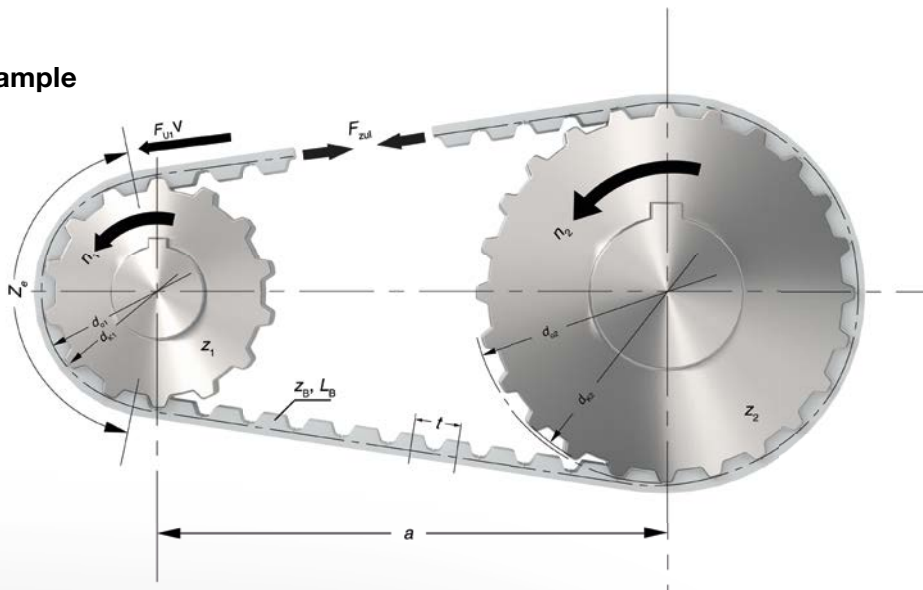

Peripheral force	F_U	[N]
specific tooth force	$F_{U\text{spec}}$	[N/cm]
admissible tensile force	F_{zul}	[N]
Pre-tension force	F_V	[N]
Shaft force	F_W	[N]
Torque	M	[Nm]
Acceleration torque	M_B	[Nm]
specific torque	M_{spec}	[Ncm/cm]
Power	P	[kW]
specific power	P_{spec}	[W/cm]
Load bearing torque	J	[kgm ²]
Load	m	[kg]
Density	ρ	[kg/dm ³]
Speed	v	[m/s]
Rotational speed	n	[min ⁻¹]
Angular speed	w	[s ⁻¹]
Frequency	f_e	[s ⁻¹]

Centre distance	a	[mm]
Belt length	L_B	[mm]
Belt width	b	[mm]
Pulley width	B	[mm]
Bore, pulley	d	[mm]
Pitch circle diameter	d_o	[mm]
Outside diameter	d_k	[mm]
Span length	L_T	[mm]
Pitch	t	[mm]
Number of belt teeth	Z_B	
Number of teeth with $i = 1$	z	
Number of teeth in mesh	Z_e	
No. of teeth, small pulley	Z_1	
No. of teeth, large pulley	Z_2	
Ratio	i	
Acceleration time	t_B	[s]

Peripheral force

$$F_U = \frac{2 \cdot 10^3 \cdot M}{d_o}$$

$$= \frac{19,1 \cdot 10^6 \cdot P}{n \cdot d_o}$$

$$= \frac{10^3 \cdot P}{v}$$

Torque

$$M = \frac{d_o \cdot F_U}{2 \cdot 10^3}$$

$$= \frac{9,55 \cdot 10^3 \cdot P}{n}$$

$$= \frac{d_o \cdot P}{2 \cdot v}$$

Power

$$P = \frac{M \cdot n}{9,55 \cdot 10^3}$$

$$= \frac{F_U \cdot d_o \cdot n}{19,1 \cdot 10^6}$$

$$= \frac{F_U \cdot v}{10^3}$$

Belt Length for $i = 1$

$$L_B = 2a + \pi \cdot d_o$$

$$= 2a + z \cdot t$$

Angular speed

$$\omega = \frac{\pi \cdot n}{30}$$

Rotational speed

$$n = \frac{19,1 \cdot 10^3 \cdot v}{d_o}$$

Speed

$$v = \frac{d_o \cdot n}{19,1 \cdot 10^3}$$

Pitch circle diameter

$$d_o = \frac{z \cdot t}{\pi}$$

Acceleration torque

$$M_B = \frac{J \cdot \Delta n}{9,55 \cdot t_B}$$

Load bearing torque

$$J = 98,2 \cdot 10^{-15} \cdot B \cdot \rho \cdot (d_k^4 - d^4)$$

Apply all equations with the dimensions mentioned here.

Calculation example

Calculation example

Task A roll table drive must be designed for heavy conveying duties. Under start-up conditions approx. 2.5 times the running torque is exerted on the timing belt.

The application conditions are:

Given:	Power	$P = 10$	kW
	Nominal speed	$n = 800$	min^{-1}
	Start-up torque	$M = 300$	Nm
	Ratio	$i = 1$	
	Number of teeth	$z = 25$	
	Centre distance	$a = 625$	mm

Required: The timing belt pitch is to be determined and the belt width is to be calculated.

Formulae: $b = \frac{100 \cdot M}{z_1 \cdot z_e \cdot M_{\text{spec}}} \quad M[\text{Nm}]$

$$b = \frac{1000 \cdot P}{z_1 \cdot z_e \cdot P_{\text{spec}}} \quad P[\text{kW}]$$

$$F_u = \frac{2 \cdot 10^3 \cdot M}{d_o} \quad F_u [\text{N}]$$

$$L = 2 \cdot a + z \cdot t \quad [\text{mm}]$$

$$d_o = \frac{z \cdot t}{\pi} \quad [\text{mm}]$$

How to proceed

Belt length: Profile preselection: AT10. Calculation of the belt length with formula:

$$\begin{aligned} L &= 2 \cdot a + z \cdot t \\ &= 2 \cdot 625 + 25 \cdot 10 \\ &= \underline{1500 \text{ mm}} \end{aligned}$$

Calculation of the belt width:

1. Tooth shear strength

In the calculation $z_e = 12$ will be used (see basis of calculation).

Calculation of the belt width with the nominal speed from the power equations.

$$\begin{aligned} b &= \frac{1000 \cdot P}{z_1 \cdot z_e \cdot P_{\text{spec}}} \\ &= \frac{1000 \cdot 10}{25 \cdot 12 \cdot 6,96} \\ &= 4,79 \text{ cm} = \underline{47,9 \text{ mm}} \end{aligned}$$

Calculation of the belt width under start-up torque when rotational speed $n = 0$.

$$\begin{aligned} b &= \frac{100 \cdot M}{z_1 \cdot z_e \cdot M_{\text{spec}}} \\ &= \frac{100 \cdot 300}{25 \cdot 12 \cdot 11,70} \\ &= 8,54 \text{ cm} = \underline{85,4 \text{ mm}} \end{aligned}$$

The belt width is to be determined from the least favourable load conditions.

Selected: the next larger standard belt width $b = \underline{100 \text{ mm}}$.

2. Tension member strength

The corresponding peripheral force can be calculated from the general data supplied:

$$\begin{aligned} F_u &= \frac{2 \cdot 10^3 \cdot M}{d_o} \\ &= \frac{2 \cdot 10^3 \cdot M}{79,58} = \underline{7539 \text{ N} < 16000 \text{ N}} \end{aligned}$$

The tabular value F_{zul} for AT 10 with 100 mm belt width is 16000 N. Thus, there is a sufficient tension member safety factor.

3. Flexibility

The design is a drive „without contraflexure“. The minimum number of teeth according to the table is adhered to.

Result: The drive is correctly designed with a belt width of 100 mm. A maintenance-free operation can be expected.

Order code: CONTI® SYNCHROFLEX 100 AT 10/1500

Calculation example

CONTI® SYNCHROFLEX Timing Belts used for transportation

Transport belts should be designed preferably with a head drive. The goods to be transported can consist of one or more individual loads. Multiple individual loads can be seen as a line load.

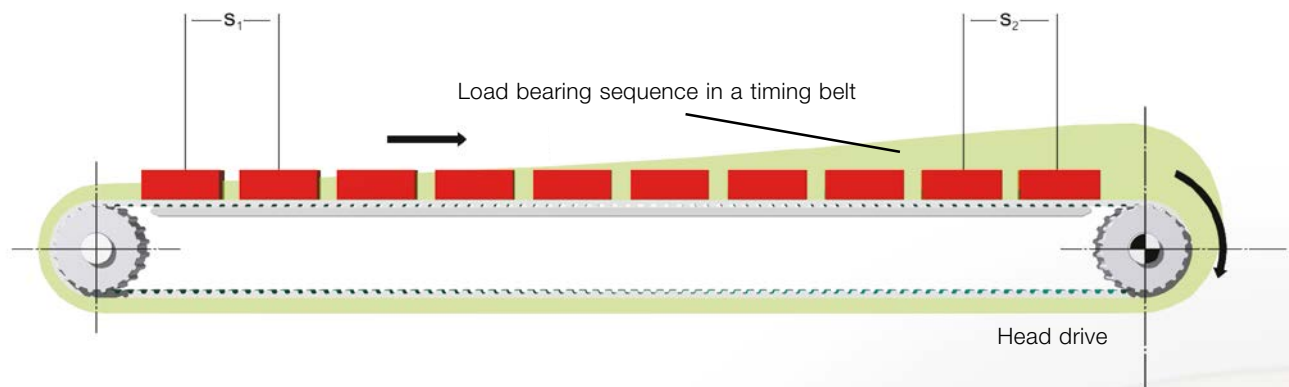

Calculation of the Peripheral force F_U

From the overall transport load, the required haul-off force or the peripheral force F_U for the drive pulley assemblies can be derived:

$$F_U = 9,81 \cdot m \cdot \mu$$

Peripheral force at the drive pulley.	F_U	[N]
Mass of the items to be transported	m	[kg]
Friction factor of the timing belt in relation to the bed plate	μ	

As friction factor μ (slide friction), the following values can be assumed:

Steel/PUR 92 Shore A	0,6 - 0,7
PE/PUR	0,3 - 0,4

In general, friction factors show large ranges. Trials should be carried out, if necessary. Errors and omissions excepted.

Information on the force/elongation behaviour

The grid surface in the picture shows the force/elongation behaviour in the timing belt under operating conditions. The individual spacing between the transported products increases towards the drive pulley due to belt elongation.

Centre $s_1 < s_2$

Pre-tension force

We recommend to set the pre-tension force in the transport timing belt such that a residual pre-tension force is always maintained on the slack span side under operating conditions. The following pre-tension force is required::

$$F_v > F_U$$

Calculating the Belt width b

$$b = \frac{F_U}{z_e \cdot F_{U\text{spec}}} \quad F_U [\text{N}]$$

F_U : peripheral force (calculated)

$F_{U\text{spec}}$: specific load of the belt teeth

AT high performance Timing Belts

AT 3 GEN III

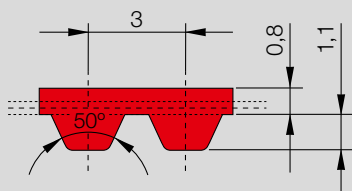

CONTI® SYNCHROFLEX Timing Belt (SFX) AT 3 GEN III

High performance AT profile with metric pitch and trapezoidal teeth.

Standard version:

- single-sided
- high performance polyurethane in red colour
- steel cord tension members with high density
- steel cord tension members in two-filament construction
- steel cord tension members in highly flexible construction

FA: with bigger back thickness

FN: with profiles on the back of the belt

Type / Length* GEN III	Number of teeth	Type / Length* GEN III	Number of teeth
AT 3 / 150	50	AT 3 / 816	272
AT 3 / 201	67	AT 3 / 816 FA	272
AT 3 / 201 FN68	67	AT 3 / 900	300
AT 3 / 252	84	AT 3 / 1011	337
AT 3 / 267	89		
AT 3 / 270	90		
AT 3 / 300	100		
AT 3 / 351	117		
AT 3 / 399	133		
AT 3 / 417	139		
AT 3 / 450	150		
AT 3 / 486 FN18	162		
AT 3 / 501	167		
AT 3 / 549	183		
AT 3 / 600	200		
AT 3 / 639	213		
AT 3 / 648	216		
AT 3 / 648 FN24	216		
AT 3 / 714	238		

Preferred belt width* in mm:
6, 10, 16, 25, 32

* Other dimensions upon request.

Order example

CONTI® SYNCHROFLEX Timing Belt 10 AT3/450 GEN III

Belt width in mm _____

Type/Pitch _____

Belt length in mm _____

Specification Generation III _____

AT 3 GEN III Technical data

1. Tooth shear strength (specific belt tooth strength)



R.p.m. n [min ⁻¹]	F _{Uspec} [N/cm]	M _{spec} [Ncm/cm]	P _{spec} [W/cm]	R.p.m. n [min ⁻¹]	F _{Uspec} [N/cm]	M _{spec} [Ncm/cm]	P _{spec} [W/cm]
0	44,44	2,12	0,00	4000	23,28	1,11	4,66
20	44,00	2,10	0,04	4500	22,36	1,07	5,03
40	43,56	2,08	0,09	5000	21,54	1,03	5,38
60	43,14	2,06	0,13	5500	20,79	0,99	5,72
80	42,74	2,04	0,17	6000	20,10	0,96	6,03
100	42,35	2,02	0,21	6500	19,46	0,93	6,32
200	40,67	1,94	0,41	7000	18,87	0,90	6,60
300	39,26	1,87	0,59	7500	18,32	0,87	6,87
400	38,06	1,82	0,76	8000	17,80	0,85	7,12
500	37,01	1,77	0,93	8500	17,31	0,83	7,36
600	36,07	1,72	1,08	9000	16,85	0,80	7,58
700	35,23	1,68	1,23	9500	16,41	0,78	7,79
800	34,47	1,65	1,38	10000	15,99	0,76	8,00
900	33,76	1,61	1,52	10500	15,59	0,74	8,19
1000	33,12	1,58	1,66	11000	15,22	0,73	8,37
1100	32,52	1,55	1,79	11500	14,85	0,71	8,54
1200	31,96	1,53	1,92	12000	14,51	0,69	8,70
1300	31,43	1,50	2,04	12500	14,17	0,68	8,86
1400	30,94	1,48	2,17	13000	13,85	0,66	9,00
1500	30,47	1,45	2,28	13500	13,54	0,65	9,14
1600	30,03	1,43	2,40	14000	13,24	0,63	9,27
1700	29,61	1,41	2,52	14500	12,96	0,62	9,39
1800	29,20	1,39	2,63	15000	12,68	0,61	9,51
1900	28,82	1,38	2,74	15500	12,41	0,59	9,62
2000	28,46	1,36	2,85	16000	12,15	0,58	9,72
2200	27,77	1,33	3,05	16500	11,89	0,57	9,81
2400	27,14	1,30	3,26	17000	11,65	0,56	9,90
2600	26,54	1,27	3,45	17500	11,41	0,54	9,98
2800	25,99	1,24	3,64	18000	11,18	0,53	10,06
3000	25,48	1,22	3,82	18500	10,95	0,52	10,13
3200	24,99	1,19	4,00	19000	10,73	0,51	10,19
3400	24,53	1,17	4,17	19500	10,52	0,50	10,25
3600	24,09	1,15	4,34	20000	10,31	0,49	10,31
3800	23,68	1,13	4,50				

Rotational speeds over 20000 rpm and/or belt speeds over 80 m/s need special drive designs. Please ask our advice.

2. Tension member strength (permitted tensile force of the belt F_{zul}), Belt weight

Belt width	b	[mm]	6	10	16	25	32
Tension member strength F _{zul}		[N]	330	599	1002	1608	2079
Belt weight	AT 3 GEN III	[kg/m]	0,016	0,026	0,042	0,065	0,083

3. Flexibility (Minimum numbers of teeth, minimum diameter)

Timing pulley	z _{min}	15		Drive type without contraflexure
Tension roller (smooth), running on teeth	d _{min} [mm]	20		
Timing pulley	z _{min}	20		Drive type with contraflexure
Tension roller (smooth), running on the back of the belt	d _{min} [mm]	20		

AT high performance Timing Belts

AT 3

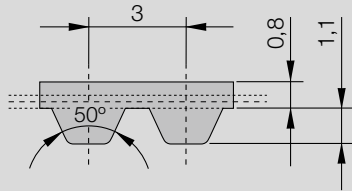

CONTI® SYNCHROFLEX Timing Belt (SFX) AT 3

High performance AT profile with metric pitch and trapezoidal teeth.

The technical data refer to standard polyurethane and standard steel cord tension members.

Available versions:

- single-sided
- with reinforced design
- with Aramide tension member
- polyurethane special materials upon request
- antistatic, coloured, mechanical reworked

FA: with bigger back thickness

FN: with profiles on the back of the belt

Type / Length*	Number of teeth
AT 3 / 150	50
AT 3 / 201	67
AT 3 / 201 FN68	67
AT 3 / 252	84
AT 3 / 267	89
<hr/>	
AT 3 / 270	90
AT 3 / 300	100
AT 3 / 351	117
AT 3 / 399	133
AT 3 / 417	139
<hr/>	
AT 3 / 450	150
AT 3 / 486 FN18	162
AT 3 / 501	167
AT 3 / 549	183
AT 3 / 600	200
<hr/>	
AT 3 / 639	213
AT 3 / 648	216
AT 3 / 648 FN24	216
AT 3 / 714	238

Type / Length*	Number of teeth
AT 3 / 816	272
AT 3 / 816 FA	272
AT 3 / 900	300
AT 3 / 1011	337

Preferred belt width* in mm:
6, 10, 16, 25, 32

* Other dimensions upon request.

Order example

CONTI® SYNCHROFLEX Timing Belt 10 AT3 / 450

Belt width in mm _____

Type/Pitch _____

Belt length in mm _____

AT 3 Technical data

1. Tooth shear strength (specific belt tooth strength)



R.p.m. n [min ⁻¹]	F _{Uspec} [N/cm]	M _{spec} [Ncm/cm]	P _{spec} [W/cm]	R.p.m. n [min ⁻¹]	F _{Uspec} [N/cm]	M _{spec} [Ncm/cm]	P _{spec} [W/cm]
0	35,55	1,70	0,00	4000	18,62	0,89	3,72
20	35,20	1,68	0,04	4500	17,89	0,85	4,03
40	34,85	1,66	0,07	5000	17,23	0,82	4,31
60	34,51	1,65	0,10	5500	16,63	0,79	4,57
80	34,19	1,63	0,14	6000	16,08	0,77	4,82
100	33,88	1,62	0,17	6500	15,57	0,74	5,06
200	32,53	1,55	0,33	7000	15,10	0,72	5,28
300	31,41	1,50	0,47	7500	14,65	0,70	5,49
400	30,45	1,45	0,61	8000	14,24	0,68	5,69
500	29,61	1,41	0,74	8500	13,85	0,66	5,88
600	28,86	1,38	0,87	9000	13,48	0,64	6,06
700	28,18	1,35	0,99	9500	13,13	0,63	6,23
800	27,57	1,32	1,10	10000	12,79	0,61	6,40
900	27,01	1,29	1,22	10500	12,48	0,60	6,55
1000	26,49	1,26	1,32	11000	12,17	0,58	6,69
1100	26,01	1,24	1,43	11500	11,88	0,57	6,83
1200	25,56	1,22	1,53	12000	11,60	0,55	6,96
1300	25,14	1,20	1,63	12500	11,34	0,54	7,09
1400	24,75	1,18	1,73	13000	11,08	0,53	7,20
1500	24,37	1,16	1,83	13500	10,83	0,52	7,31
1600	24,02	1,15	1,92	14000	10,60	0,51	7,42
1700	23,68	1,13	2,01	14500	10,36	0,49	7,51
1800	23,36	1,12	2,10	15000	10,14	0,48	7,61
1900	23,06	1,10	2,19	15500	9,93	0,47	7,69
2000	22,77	1,09	2,28	16000	9,72	0,46	7,77
2200	22,22	1,06	2,44	16500	9,51	0,45	7,85
2400	21,71	1,04	2,60	17000	9,32	0,44	7,92
2600	21,24	1,01	2,76	17500	9,13	0,44	7,99
2800	20,79	0,99	2,91	18000	8,94	0,43	8,05
3000	20,38	0,97	3,06	18500	8,76	0,42	8,10
3200	19,99	0,95	3,20	19000	8,58	0,41	8,15
3400	19,62	0,94	3,34	19500	8,41	0,40	8,20
3600	19,27	0,92	3,47	20000	8,25	0,39	8,24
3800	18,94	0,90	3,60				

Rotational speeds over 20000 rpm and/or belt speeds over 80 m/s need special drive designs. Please ask our advice.

2. Tension member strength (permitted tensile force of the belt F_{zul}), Belt weight

Belt width	b	[mm]	6	10	16	25	32
Tension member strength F _{zul}		[N]	190	380	646	1102	1406
Belt weight	AT 3	[kg/m]	0,014	0,023	0,037	0,058	0,074

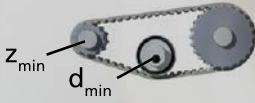
3. Flexibility (Minimum numbers of teeth, minimum diameter)

Timing pulley	z _{min}	15		Drive type without contraflexure
Tension roller (smooth), running on teeth	d _{min} [mm]	20		
Timing pulley	z _{min}	20		Drive type with contraflexure
Tension roller (smooth), running on the back of the belt	d _{min} [mm]	20		

AT high performance Timing Belts

AT 5 GEN III

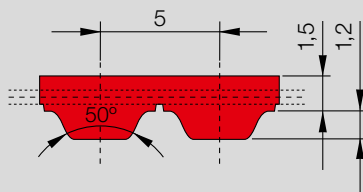

CONTI® SYNCHROFLEX Timing Belt (SFX) AT 5 GEN III

High performance AT profile with metric pitch and trapezoidal teeth.

Standard version:

- single-sided
- high performance polyurethane in red colour
- steel cord tension members with high density
- steel cord tension members in two-filament construction
- steel cord tension members in highly flexible construction

FA: with bigger back thickness

Type / Length* GEN III	Number of teeth	Type / Length* GEN III	Number of teeth
AT 5 / 225	45	AT 5 / 720	144
AT 5 / 255	51	AT 5 / 750	150
AT 5 / 260	52	AT 5 / 780	156
AT 5 / 280	56	AT 5 / 825	165
AT 5 / 300	60	AT 5 / 860	172
AT 5 / 330	66	AT 5 / 875	175
AT 5 / 340	68	AT 5 / 900	180
AT 5 / 375	75	AT 5 / 920	184
AT 5 / 390	78	AT 5 / 975	195
AT 5 / 420	84	AT 5 / 1050	210
AT 5 / 450	90	AT 5 / 1125	225
AT 5 / 455	91	AT 5 / 1230	246
AT 5 / 480	96	AT 5 / 1500	300
AT 5 / 490	98	AT 5 / 1750	350
AT 5 / 500	100	AT 5 / 2000	400
AT 5 / 525	105	AT 5 / 3350 FA**	670
AT 5 / 545	109	AT 5 / 3800 FA**	760
AT 5 / 600	120		
AT 5 / 610	122		
AT 5 / 620	124		
AT 5 / 630	126		
AT 5 / 660	132		
AT 5 / 670	134		
AT 5 / 690	138		
AT 5 / 710	142		

Preferred belt width* in mm:
6, 10, 16, 25, 32, 50, 75, 100

* Other dimensions upon request.
** Please request technical support from your Mulco sales partner.

Order example

CONTI® SYNCHROFLEX Timing Belt 50 AT5 / 450 GEN III

Belt width in mm _____

Type/Pitch _____

Belt length in mm _____

Specification Generation III _____

AT 5 GEN III Technical data

1. Tooth shear strength (specific belt tooth strength)



R.p.m. n [min ⁻¹]	F _{Uspec} [N/cm]	M _{spec} [Ncm/cm]	P _{spec} [W/cm]	R.p.m. n [min ⁻¹]	F _{Uspec} [N/cm]	M _{spec} [Ncm/cm]	P _{spec} [W/cm]
0	48,48	3,86	0,00	2000	30,07	2,39	5,01
20	47,96	3,82	0,08	2200	29,29	2,33	5,37
40	47,43	3,77	0,16	2400	28,57	2,27	5,71
60	46,94	3,74	0,23	2600	27,91	2,22	6,05
80	46,47	3,70	0,31	2800	27,28	2,17	6,37
100	46,02	3,66	0,38	3000	26,70	2,12	6,67
200	44,05	3,51	0,73	3200	26,14	2,08	6,97
300	42,42	3,38	1,06	3400	25,62	2,04	7,26
400	41,03	3,27	1,37	3600	25,13	2,00	7,54
500	39,82	3,17	1,66	3800	24,66	1,96	7,81
600	38,75	3,08	1,94	4000	24,21	1,93	8,07
700	37,78	3,01	2,20	4500	23,18	1,84	8,69
800	36,91	2,94	2,46	5000	22,25	1,77	9,27
900	36,11	2,87	2,71	5500	21,40	1,70	9,81
1000	35,37	2,81	2,95	6000	20,62	1,64	10,31
1100	34,68	2,76	3,18	6500	19,90	1,58	10,78
1200	34,05	2,71	3,40	7000	19,24	1,53	11,22
1300	33,45	2,66	3,62	7500	18,61	1,48	11,63
1400	32,88	2,62	3,84	8000	18,03	1,43	12,02
1500	32,35	2,57	4,04	8500	17,48	1,39	12,38
1600	31,85	2,53	4,25	9000	16,95	1,35	12,71
1700	31,37	2,50	4,44	9500	16,46	1,31	13,03
1800	30,92	2,46	4,64	10000	15,99	1,27	13,33
1900	30,49	2,43	4,83				

Rotational speeds over 10000 rpm and/or belt speeds over 80 m/s need special drive designs. Please ask our advice.

2. Tension member strength (permitted tensile force of the belt F_{zul}), Belt weight

Belt width b [mm]		6	10	16	25	32	50	75	100
Tension member strength F _{zul} [N]		417	787	1342	2175	2823	4489	6803	9117
Belt weight AT 5 GEN III [kg/m]		0,022	0,036	0,058	0,090	0,115	0,180	0,270	0,360

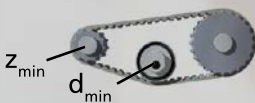
3. Flexibility (Minimum numbers of teeth, minimum diameter)

Timing pulley	z _{min}	15		Drive type without contraflexure
Tension roller (smooth), running on teeth	d _{min} [mm]	25		
Timing pulley	z _{min}	20		Drive type with contraflexure
Tension roller (smooth), running on the back of the belt	d _{min} [mm]	60		

AT high performance Timing Belts

AT 5

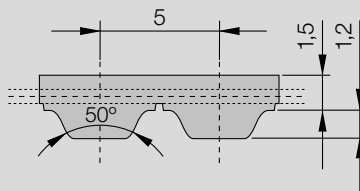

CONTI® SYNCHROFLEX Timing Belt (SFX) AT 5

High performance AT profile with metric pitch and trapezoidal teeth.

The technical data refer to standard polyurethane and standard steel cord tension members.

Available versions:

- single-sided
- with "E" tension member for a better flexibility
- with reinforced design
- with Aramide tension member
- polyurethane special materials upon request
- antistatic, coloured, mechanical reworked

Type / Length*	Number of teeth	Type / Length*	Number of teeth
AT 5 / 225	45	AT 5 / 720	144
AT 5 / 255	51	AT 5 / 750	150
AT 5 / 260	52	AT 5 / 780	156
AT 5 / 280	56	AT 5 / 825	165
AT 5 / 300	60	AT 5 / 860	172
AT 5 / 330	66	AT 5 / 875	175
AT 5 / 340	68	AT 5 / 900	180
AT 5 / 375	75	AT 5 / 920	184
AT 5 / 390	78	AT 5 / 975	195
AT 5 / 420	84	AT 5 / 1050	210
AT 5 / 450	90	AT 5 / 1125	225
AT 5 / 455	91	AT 5 / 1230	246
AT 5 / 480	96	AT 5 / 1500	300
AT 5 / 490	98	AT 5 / 1750	350
AT 5 / 500	100	AT 5 / 2000	400
AT 5 / 525	105	AT 5 / 3350 FA**	670
AT 5 / 545	109	AT 5 / 3800 FA**	760
AT 5 / 600	120		
AT 5 / 610	122		
AT 5 / 620	124		
AT 5 / 630	126		
AT 5 / 660	132		
AT 5 / 670	134		
AT 5 / 690	138		
AT 5 / 710	142		

Preferred belt width* in mm:
10, 16, 25, 32, 50

* Other dimensions upon request.
** Please request technical support from your Mulco sales partner.

Order example

CONTI® SYNCHROFLEX Timing Belt 10 AT5/450

Belt width in mm _____
 Type/Pitch _____
 Belt length in mm _____

AT 5 Technical data

1. Tooth shear strength (specific belt tooth strength)



R.p.m. n [min ⁻¹]	F _{Uspec} [N/cm]	M _{spec} [Ncm/cm]	P _{spec} [W/cm]	R.p.m. n [min ⁻¹]	F _{Uspec} [N/cm]	M _{spec} [Ncm/cm]	P _{spec} [W/cm]
0	38,79	3,09	0,00	2000	24,06	1,91	4,01
20	38,37	3,05	0,06	2200	23,43	1,86	4,30
40	37,95	3,02	0,13	2400	22,86	1,82	4,57
60	37,55	2,99	0,19	2600	22,32	1,78	4,84
80	37,17	2,96	0,25	2800	21,83	1,74	5,09
100	36,82	2,93	0,31	3000	21,36	1,70	5,34
200	35,24	2,80	0,59	3200	20,92	1,66	5,58
300	33,94	2,70	0,85	3400	20,50	1,63	5,81
400	32,83	2,61	1,09	3600	20,10	1,60	6,03
500	31,86	2,54	1,33	3800	19,73	1,57	6,25
600	31,00	2,47	1,55	4000	19,37	1,54	6,46
700	30,23	2,41	1,76	4500	18,54	1,48	6,95
800	29,53	2,35	1,97	5000	17,80	1,42	7,42
900	28,89	2,30	2,17	5500	17,12	1,36	7,85
1000	28,29	2,25	2,36	6000	16,50	1,31	8,25
1100	27,75	2,21	2,54	6500	15,92	1,27	8,62
1200	27,24	2,17	2,72	7000	15,39	1,22	8,98
1300	26,76	2,13	2,90	7500	14,89	1,18	9,31
1400	26,31	2,09	3,07	8000	14,42	1,15	9,61
1500	25,88	2,06	3,24	8500	13,98	1,11	9,90
1600	25,48	2,03	3,40	9000	13,56	1,08	10,17
1700	25,10	2,00	3,56	9500	13,17	1,05	10,42
1800	24,74	1,97	3,71	10000	12,79	1,02	10,66
1900	24,39	1,94	3,86				

Rotational speeds over 10000 rpm and/or belt speeds over 80 m/s need special drive designs. Please ask our advice.

2. Tension member strength (permitted tensile force of the belt F_{zul}), Belt weight

Belt width	b	[mm]	6	10	16	25	32	50	75	100
Tension member strength F _{zul}		[N]	350	700	1260	2030	2660	4200	6370	8610
Belt weight	AT 5	[kg/m]	0,020	0,034	0,054	0,085	0,109	0,170	0,255	0,340

3. Flexibility (Minimum numbers of teeth, minimum diameter)

Timing pulley	z _{min}	15		Drive type without contraflexure
Tension roller (smooth), running on teeth	d _{min} [mm]	25		
Timing pulley	z _{min}	20		Drive type with contraflexure
Tension roller (smooth), running on the back of the belt	d _{min} [mm]	60		

AT high performance Timing Belts

AT 10 GEN III

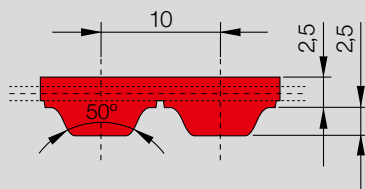

CONTI® SYNCHROFLEX Timing Belt (SFX) AT 10 GEN III

High performance AT profile with metric pitch and trapezoidal teeth.

Standard version:

- single-sided
- high performance polyurethane in red colour
- steel cord tension members with high density
- steel cord tension members in two-filament construction

FN: with profiles on the back of the belt

Type / Length* GEN III	Number of teeth	Type / Length* GEN III	Number of teeth
AT 10 / 440	44	AT 10 / 1150	115
AT 10 / 460	46	AT 10 / 1200	120
AT 10 / 500	50	AT 10 / 1210	121
AT 10 / 560	56	AT 10 / 1250	125
AT 10 / 570	57	AT 10 / 1280	128
AT 10 / 580	58	AT 10 / 1300	130
AT 10 / 600	60	AT 10 / 1320	132
AT 10 / 610	61	AT 10 / 1350	135
AT 10 / 660	66	AT 10 / 1360	136
AT 10 / 700	70	AT 10 / 1360 FN2	136
AT 10 / 730	73	AT 10 / 1400	140
AT 10 / 780	78	AT 10 / 1480	148
AT 10 / 800	80	AT 10 / 1500	150
AT 10 / 840	84	AT 10 / 1600	160
AT 10 / 840 FN2	84	AT 10 / 1700	170
AT 10 / 880	88	AT 10 / 1720	172
AT 10 / 890	89	AT 10 / 1800	180
AT 10 / 920	92	AT 10 / 1860	186
AT 10 / 960	96	AT 10 / 1940	194
AT 10 / 980	98	AT 10 / 2910 FN2	291
AT 10 / 1000	100		
AT 10 / 1010	101		
AT 10 / 1050	105		
AT 10 / 1080	108		
AT 10 / 1100	110		

Preferred belt width* in mm:
16, 25, 32, 50, 75, 100, 150

* Other dimensions upon request.

Order example

CONTI® SYNCHROFLEX Timing Belt **32 AT10/800 GEN III**

Belt width in mm _____

Type/Pitch _____

Belt length in mm _____

Specification Generation III _____

AT 10 GEN III Technical data

1. Tooth shear strength (specific belt tooth strength)



R.p.m. n [min ⁻¹]	F _{Uspec} [N/cm]	M _{spec} [Ncm/cm]	P _{spec} [W/cm]	R.p.m. n [min ⁻¹]	F _{Uspec} [N/cm]	M _{spec} [Ncm/cm]	P _{spec} [W/cm]
0	100,99	16,07	0,00	2000	55,45	8,82	18,48
20	99,58	15,85	0,33	2200	53,61	8,53	19,65
40	98,19	15,63	0,65	2400	51,91	8,26	20,76
60	96,88	15,42	0,97	2600	50,33	8,01	21,81
80	95,65	15,22	1,28	2800	48,86	7,78	22,80
100	94,48	15,04	1,57	3000	47,48	7,56	23,74
200	89,43	14,23	2,98	3200	46,19	7,35	24,63
300	85,32	13,58	4,27	3400	44,96	7,16	25,48
400	81,86	13,03	5,46	3600	43,80	6,97	26,28
500	78,88	12,55	6,57	3800	42,70	6,80	27,04
600	76,25	12,14	7,62	4000	41,65	6,63	27,77
700	73,90	11,76	8,62	4500	39,23	6,24	29,42
800	71,78	11,42	9,57	5000	37,05	5,90	30,87
900	69,85	11,12	10,48	5500	35,07	5,58	32,14
1000	68,07	10,83	11,34	6000	33,25	5,29	33,25
1100	66,43	10,57	12,18	6500	31,57	5,02	34,20
1200	64,90	10,33	12,98	7000	30,01	4,78	35,01
1300	63,47	10,10	13,75	7500	28,55	4,54	35,69
1400	62,13	9,89	14,50	8000	27,19	4,33	36,25
1500	60,86	9,69	15,21	8500	25,90	4,12	36,69
1600	59,67	9,50	15,91	9000	24,69	3,93	37,03
1700	58,53	9,32	16,58	9500	23,54	3,75	37,26
1800	57,46	9,14	17,24	10000	22,44	3,57	37,40
1900	56,43	8,98	17,87				

Rotational speeds over 10000 rpm and/or belt speeds over 60 m/s need special drive designs. Please ask our advice.

2. Tension member strength (permitted tensile force of the belt F_{zul}), Belt weight

Belt width	b	[mm]	16	25	32	50	75	100	150
Tension member strength F _{zul}		[N]	3000	5000	6750	10750	16500	22000	33500
Belt weight	AT 10 GEN III	[kg/m]	0,117	0,183	0,234	0,365	0,548	0,730	1,095

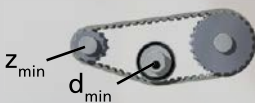
3. Flexibility (Minimum numbers of teeth, minimum diameter)

Timing pulley	z _{min}	15		Drive type without contraflexure
Tension roller (smooth), running on teeth	d _{min} [mm]	50		
Timing pulley	z _{min}	25		Drive type with contraflexure
Tension roller (smooth), running on the back of the belt	d _{min} [mm]	120		

AT high performance Timing Belts

AT 10

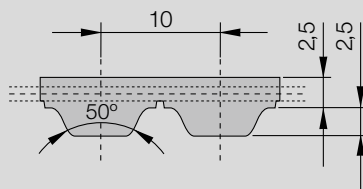

CONTI® SYNCHROFLEX Timing Belt (SFX) AT 10

High performance AT profile with metric pitch and trapezoidal teeth.

The technical data refer to standard polyurethane and standard steel cord tension members.

Available versions:

- single-sided
- with "E" tension member for a better flexibility
- with reinforced design
- with Aramide tension member
- polyurethane special materials upon request
- antistatic, coloured, mechanical reworked

FN: with profiles on the back of the belt

Type / Length*	Number of teeth	Type / Length*	Number of teeth
AT 10 / 440	44	AT 10 / 1150	115
AT 10 / 460	46	AT 10 / 1200	120
AT 10 / 500	50	AT 10 / 1210	121
AT 10 / 560	56	AT 10 / 1250	125
AT 10 / 570	57	AT 10 / 1280	128
AT 10 / 580	58	AT 10 / 1300	130
AT 10 / 600	60	AT 10 / 1320	132
AT 10 / 610	61	AT 10 / 1350	135
AT 10 / 660	66	AT 10 / 1360	136
AT 10 / 700	70	AT 10 / 1360 FN2	136
AT 10 / 730	73	AT 10 / 1400	140
AT 10 / 780	78	AT 10 / 1480	148
AT 10 / 800	80	AT 10 / 1500	150
AT 10 / 840	84	AT 10 / 1600	160
AT 10 / 840 FN2	84	AT 10 / 1700	170
AT 10 / 880	88	AT 10 / 1720	172
AT 10 / 890	89	AT 10 / 1800	180
AT 10 / 920	92	AT 10 / 1860	186
AT 10 / 960	96	AT 10 / 1940	194
AT 10 / 980	98	AT 10 / 2910 FN2	291
AT 10 / 1000	100		
AT 10 / 1010	101		
AT 10 / 1050	105		
AT 10 / 1080	108		
AT 10 / 1100	110		

Preferred belt width* in mm:
16, 25, 32, 50, 75, 100

* Other dimensions upon request.

Order example

CONTI® SYNCHROFLEX Timing Belt 32 AT10/800

Belt width in mm _____

Type/Pitch _____

Belt length in mm _____

AT 10 Technical data

1. Tooth shear strength (specific belt tooth strength)



R.p.m. n [min ⁻¹]	F _{Uspec} [N/cm]	M _{spec} [Ncm/cm]	P _{spec} [W/cm]	R.p.m. n [min ⁻¹]	F _{Uspec} [N/cm]	M _{spec} [Ncm/cm]	P _{spec} [W/cm]
0	80,79	12,86	0,00	2000	44,36	7,06	14,78
20	79,66	12,68	0,27	2200	42,89	6,83	15,72
40	78,55	12,50	0,52	2400	41,53	6,61	16,61
60	77,51	12,34	0,78	2600	40,27	6,41	17,45
80	76,52	12,18	1,02	2800	39,09	6,22	18,24
100	75,59	12,03	1,26	3000	37,99	6,05	18,99
200	71,54	11,39	2,38	3200	36,95	5,88	19,71
300	68,26	10,86	3,41	3400	35,97	5,72	20,38
400	65,49	10,42	4,37	3600	35,04	5,58	21,02
500	63,10	10,04	5,26	3800	34,16	5,44	21,63
600	61,00	9,71	6,10	4000	33,32	5,30	22,21
700	59,12	9,41	6,90	4500	31,39	5,00	23,54
800	57,43	9,14	7,66	5000	29,64	4,72	24,70
900	55,88	8,89	8,38	5500	28,05	4,47	25,71
1000	54,46	8,67	9,08	6000	26,60	4,23	26,60
1100	53,14	8,46	9,74	6500	25,26	4,02	27,36
1200	51,92	8,26	10,38	7000	24,01	3,82	28,01
1300	50,78	8,08	11,00	7500	22,84	3,64	28,55
1400	49,70	7,91	11,60	8000	21,75	3,46	29,00
1500	48,69	7,75	12,17	8500	20,72	3,30	29,35
1600	47,73	7,60	12,73	9000	19,75	3,14	29,62
1700	46,83	7,45	13,27	9500	18,83	3,00	29,81
1800	45,97	7,32	13,79	10000	17,95	2,86	29,92
1900	45,14	7,18	14,29				

Rotational speeds over 10000 rpm and/or belt speeds over 60 m/s need special drive designs. Please ask our advice.

2. Tension member strength (permitted tensile force of the belt F_{zul}), Belt weight

Belt width	b	[mm]	16	25	32	50	75	100	150
Tension member strength F _{zul}		[N]	2000	3500	4750	7750	12000	16000	24500
Belt weight	AT 10	[kg/m]	0,101	0,158	0,202	0,315	0,473	0,630	0,945

3. Flexibility (Minimum numbers of teeth, minimum diameter)

Timing pulley	Z _{min}	15		Drive type without contraflexure
Tension roller (smooth), running on teeth	d _{min} [mm]	50		
Timing pulley	Z _{min}	25		Drive type with contraflexure
Tension roller (smooth), running on the back of the belt	d _{min} [mm]	120		

ATP high performance Timing Belts

ATP 10 GEN III

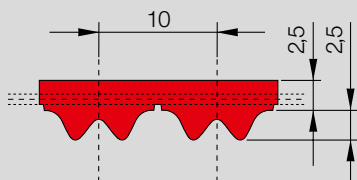

CONTI® SYNCHROFLEX Timing Belt (SFX) ATP 10 GEN III

High performance ATP profile with metric pitch and optimised meshing of the double engagement toothform.

Standard version

- single-sided
- high performance polyurethane in red colour
- steel cord tension members with high density
- steel cord tension members in two-filament construction

Type / Length* GEN III	Number of teeth	Type / Length* GEN III	Number of teeth
ATP 10 / 630	63	ATP 10 / 1280	128
ATP 10 / 660	66	ATP 10 / 1400	140
ATP 10 / 700	70	ATP 10 / 1650	165
ATP 10 / 780	78	ATP 10 / 1800	180
ATP 10 / 840	84		
ATP 10 / 890	89		
ATP 10 / 920	92		
ATP 10 / 1010	101		
ATP 10 / 1080	108		
ATP 10 / 1150	115		

Preferred belt width* in mm:
16, 25, 32, 50, 75, 100, 150

* Other dimensions upon request.

Order example

CONTI® SYNCHROFLEX Timing Belt 32 ATP10/780 GEN III

Belt width in mm _____

Type/Pitch _____

Belt length in mm _____

Specification Generation III _____

ATP 10 GEN III Technical data

1. Tooth shear strength (specific belt tooth strength)



R.p.m. n [min ⁻¹]	F _{Uspec} [N/cm]	M _{spec} [Ncm/cm]	P _{spec} [W/cm]	R.p.m. n [min ⁻¹]	F _{Uspec} [N/cm]	M _{spec} [Ncm/cm]	P _{spec} [W/cm]
0	105,050	16,713	0,000	2000	57,636	9,170	19,205
20	103,508	16,468	0,345	2200	55,722	8,865	20,425
40	102,064	16,238	0,680	2400	53,957	8,584	21,575
60	100,706	16,023	1,007	2600	52,318	8,324	22,663
80	99,424	15,818	1,326	2800	50,790	8,081	23,694
100	98,210	15,626	1,637	3000	49,358	7,853	24,671
150	95,432	15,183	2,385	3200	48,010	7,638	25,597
200	92,956	14,790	3,098	3400	46,737	7,436	26,476
300	88,706	14,110	4,433	3600	45,532	7,245	27,310
400	85,093	13,538	5,671	3800	44,387	7,062	28,102
500	81,989	13,045	6,830	4000	43,297	6,888	28,855
600	79,257	12,609	7,923	4500	40,780	6,488	30,575
700	76,817	12,222	8,985	5000	38,513	6,127	32,084
800	74,614	11,871	9,945	5500	36,452	5,799	33,403
900	72,604	11,551	10,887	6000	34,561	5,499	34,549
1000	70,758	11,257	11,789	6500	32,815	5,221	35,538
1100	69,049	10,986	12,654	7000	31,194	4,963	36,380
1200	67,461	10,733	13,487	7500	29,679	4,722	37,087
1300	65,975	10,496	14,290	8000	28,260	4,496	37,666
1400	64,580	10,275	15,063	8500	26,923	4,283	38,128
1500	63,265	10,065	15,811	9000	25,661	4,082	38,477
1600	62,022	9,868	16,534	9500	24,464	3,892	38,721
1700	60,844	9,680	17,234	10000	23,328	3,711	38,865
1800	59,723	9,502	17,911				
1900	58,655	9,332	18,568				

Rotational speeds over 10000 rpm and/or belt speeds over 60 m/s need special drive designs. Please ask our advice.

2. Tension member strength (permitted tensile force of the belt F_{zul}), Belt weight

Belt width	b	[mm]	16	25	32	50	75	100	150
Tension member strength F _{zul}		[N]	3000	5000	6750	10750	16500	22000	33500
Belt weight	ATP 10 GEN III	[kg/m]	0,109	0,170	0,218	0,340	0,510	0,680	1,020

3. Flexibility (Minimum numbers of teeth, minimum diameter)

Timing pulley	z _{min}	15		Drive type without contraflexure
Tension roller (smooth), running on teeth	d _{min} [mm]	50		
Timing pulley	z _{min}	25		Drive type with contraflexure
Tension roller (smooth), running on the back of the belt	d _{min} [mm]	120		

ATP high performance Timing Belts

ATP 10

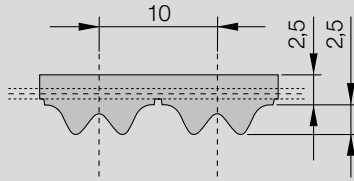

CONTI® SYNCHROFLEX Timing Belt (SFX) ATP 10

High performance ATP profile with metric pitch and optimised meshing of the double engagement toothform.

The technical data refer to standard polyurethane and standard steel cord tension members.

Available versions:

- single-sided
- with “E” tension member for a better flexibility
- with reinforced tension member design
- polyurethane special materials upon request (Standard: 93ShA, colour: red)
- antistatic, coloured, mechanical reworked

Type / Length*	Number of teeth	Type / Length*	Number of teeth
ATP 10 / 630	63	ATP 10 / 1280	128
ATP 10 / 660	66	ATP 10 / 1400	140
ATP 10 / 700	70	ATP 10 / 1650	165
ATP 10 / 780	78	ATP 10 / 1800	180
ATP 10 / 840	84		
ATP 10 / 890	89		
ATP 10 / 920	92		
ATP 10 / 1010	101		
ATP 10 / 1080	108		
ATP 10 / 1150	115		

Preferred belt width* in mm:
16, 25, 32, 50, 75, 100

* Other dimensions upon request.

Order example

CONTI® SYNCHROFLEX Timing Belt 32 ATP10/780

Belt width in mm _____

Type/Pitch _____

Belt length in mm _____

ATP 10 Technical data

1. Tooth shear strength (specific belt tooth strength)



R.p.m. n [min ⁻¹]	F _{Uspec} [N/cm]	M _{spec} [Ncm/cm]	P _{spec} [W/cm]	R.p.m. n [min ⁻¹]	F _{Uspec} [N/cm]	M _{spec} [Ncm/cm]	P _{spec} [W/cm]
0	95,500	15,199	0,000	2000	52,396	8,339	17,464
20	94,098	14,976	0,314	2200	50,656	8,062	18,572
40	92,785	14,767	0,619	2400	49,052	7,807	19,619
60	91,551	14,571	0,915	2600	47,562	7,570	20,609
80	90,385	14,385	1,205	2800	46,173	7,349	21,546
100	89,282	14,210	1,488	2880	45,642	7,264	21,907
150	86,756	13,808	2,169	3000	44,871	7,141	22,434
200	84,505	13,449	2,817	3200	43,645	6,946	23,276
300	80,642	12,835	4,032	3400	42,488	6,762	24,075
400	77,357	12,312	5,157	3600	41,393	6,588	24,834
500	74,535	11,863	6,211	3800	40,352	6,422	25,554
600	72,052	11,467	7,205	4000	39,361	6,264	26,239
700	69,834	11,114	8,147	4500	37,073	5,900	27,803
730	69,212	11,015	8,420	5000	35,012	5,572	29,175
800	67,831	10,796	9,043	5500	33,138	5,274	30,374
900	66,004	10,505	9,900	6000	31,419	5,000	31,417
1000	64,325	10,238	10,720	6500	29,832	4,748	32,316
1100	62,772	9,990	11,507	7000	28,358	4,513	33,082
1200	61,328	9,761	12,265	7500	26,981	4,294	33,724
1300	59,977	9,546	12,994	8000	25,691	4,089	34,252
1400	58,709	9,344	13,698	8500	24,475	3,895	34,670
1460	57,984	9,228	14,108	9000	23,328	3,713	34,989
1500	57,514	9,154	14,377	9500	22,240	3,540	35,211
1600	56,348	8,968	15,025	10000	21,207	3,375	35,342
1700	55,313	8,803	15,671				
1800	54,294	8,641	16,287				
1900	53,323	8,487	16,884				

Rotational speeds over 10000 rpm and/or belt speeds over 60 m/s need special drive designs. Please ask for our advice.

2. Tension member strength (permitted tensile force of the belt F_{zul}), Belt weight

Belt width	b	[mm]	16	25	32	50	75	100	150
Tension member strength F _{zul}		[N]	2000	3500	4750	7750	12000	16000	24500
Belt weight	ATP 10	[kg/m]	0,096	0,150	0,192	0,300	0,450	0,600	0,900

3. Flexibility (Minimum numbers of teeth, minimum diameter)

Timing pulley	z _{min}	15		Drive type without contraflexure
Tension roller (smooth), running on teeth	d _{min} [mm]	50		
Timing pulley	z _{min}	25		Drive type with contraflexure
Tension roller (smooth), running on the back of the belt	d _{min} [mm]	120		

ATP high performance Timing Belts

ATP 15 GEN III

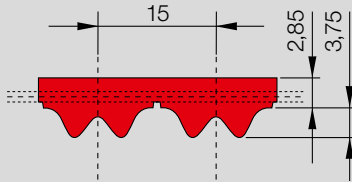

CONTI® SYNCHROFLEX Timing Belt (SFX) ATP 15 GEN III

High performance ATP profile with metric pitch and optimised meshing of the double engagement toothform.

Standard version

- single-sided
- high performance polyurethane in red colour
- steel cord tension members with high density
- steel cord tension members in two-filament construction

Type / Length* GEN III	Number of teeth	Type / Length* GEN III	Number of teeth
ATP 15 / 1125	75	ATP 15 / 1260	84
ATP 15 / 1185	79	ATP 15 / 1560	104

Preferred belt width* in mm:
25, 32, 50, 75, 100, 150

* Other dimensions upon request.

Order example

CONTI® SYNCHROFLEX Timing Belt 32 ATP15/1260 GEN III

Belt width in mm _____
 Type/Pitch _____
 Belt length in mm _____
 Specification Generation III _____

ATP 15 GEN III Technical data

1. Tooth shear strength (specific belt tooth strength)



R.p.m. n [min ⁻¹]	F _{Uspec} [N/cm]	M _{spec} [Ncm/cm]	P _{spec} [W/cm]	R.p.m. n [min ⁻¹]	F _{Uspec} [N/cm]	M _{spec} [Ncm/cm]	P _{spec} [W/cm]
0	157,672	37,641	0,000	2000	79,185	18,904	39,592
20	155,054	37,016	0,775	2200	76,062	18,158	41,834
40	152,609	36,433	1,526	2400	73,182	17,471	43,909
60	150,315	35,885	2,255	2600	70,510	16,833	45,831
80	148,155	35,369	2,963	2800	68,018	16,238	47,612
100	146,114	34,882	3,653	3000	65,683	15,681	49,262
150	141,455	33,770	5,305	3200	63,486	15,156	50,789
200	137,318	32,782	6,866	3400	61,413	14,661	52,201
300	130,215	31,087	9,766	3600	59,449	14,192	53,504
400	124,258	29,664	12,426	3800	57,584	13,747	54,705
500	119,128	28,440	14,891	4000	55,809	13,323	55,809
600	114,623	27,364	17,193	4500	51,711	12,345	58,175
700	110,606	26,405	19,356	5000	48,022	11,464	60,027
800	106,984	25,540	21,397	5500	44,667	10,663	61,417
900	103,684	24,753	23,329	6000	41,591	9,929	62,386
1000	100,564	24,029	25,163	6500	38,751	9,251	62,970
1100	97,853	23,361	26,910	7000	36,113	8,621	63,198
1200	95,250	22,739	28,575	7500	33,651	8,034	63,095
1300	92,817	22,159	30,166	8000	31,342	7,482	62,684
1400	90,535	21,614	31,687	8500	29,169	6,964	61,984
1500	88,385	21,100	33,144	9000	27,116	6,474	61,012
1600	86,353	20,615	34,541	9500	25,171	6,009	59,782
1700	84,427	20,155	35,881	10000	23,324	5,568	58,309
1800	82,596	19,718	37,168				
1900	80,851	19,302	38,404				

Rotational speeds over 10000 rpm and/or belt speeds over 50 m/s need special drive designs. Please ask for our advice.

2. Tension member strength (permitted tensile force of the belt F_{zul}), Belt weight

Belt width	b	[mm]	25	32	50	75	100	150
Tension member strength F _{zul}		[N]	6300	8550	13950	21600	28800	44100
Belt weight	ATP 15 GEN III	[kg/m]	0,218	0,279	0,436	0,654	0,872	1,308

3. Flexibility (Minimum numbers of teeth, minimum diameter)

Timing pulley	z _{min}	20		Drive type without contraflexure
Tension roller (smooth), running on teeth	d _{min} [mm]	100		
Timing pulley	z _{min}	30		Drive type with contraflexure
Tension roller (smooth), running on the back of the belt	d _{min} [mm]	160		

ATP high performance Timing Belts

ATP 15

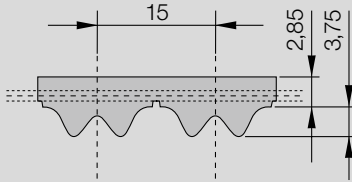

CONTI® SYNCHROFLEX Timing Belt (SFX) ATP 15

High performance ATP profile with metric pitch and optimised meshing of the double engagement toothform.

Available versions:

- single-sided
- with "E" tension member for a better flexibility
- with reinforced tension member design
- polyurethane special materials upon request (Standard: 93ShA, colour: red)
- antistatic, coloured, mechanical reworked

Type / Length* GEN III	Number of teeth	Type / Length* GEN III	Number of teeth
ATP 15 / 1125	75	ATP 15 / 1260	84
ATP 15 / 1185	79	ATP 15 / 1560	104

Preferred belt width* in mm:
25, 32, 50, 75, 100, 150

* Other dimensions upon request.

Order example

CONTI® SYNCHROFLEX Timing Belt 32 ATP15/1260

Belt width in mm _____

Type/Pitch _____

Belt length in mm _____

ATP 15 Technical data

1. Tooth shear strength (specific belt tooth strength)



R.p.m. n [min ⁻¹]	F _{Uspec} [N/cm]	M _{spec} [Ncm/cm]	P _{spec} [W/cm]	R.p.m. n [min ⁻¹]	F _{Uspec} [N/cm]	M _{spec} [Ncm/cm]	P _{spec} [W/cm]
0	143,325	34,216	0,000	2000	71,980	17,184	35,990
20	140,945	33,648	0,705	2200	69,141	16,506	38,027
40	138,722	33,117	1,387	2400	66,523	15,881	39,914
60	136,637	32,620	2,050	2600	64,094	15,301	41,661
80	134,674	32,151	2,693	2800	61,828	14,760	43,280
100	132,818	31,708	3,320	3000	59,706	14,254	44,779
150	128,584	30,697	4,822	3200	57,709	13,777	46,167
200	124,832	29,799	6,241	3400	55,824	13,327	47,451
300	118,367	28,258	8,877	3600	54,040	12,901	48,636
400	112,952	26,965	11,295	3800	52,345	12,496	49,727
500	108,288	25,852	13,536	4000	50,731	12,111	50,731
600	104,193	24,874	15,629	4500	47,006	11,222	52,881
700	100,542	24,003	17,595	5000	43,652	10,421	54,565
800	97,249	23,216	19,450	5500	40,602	9,693	55,828
900	94,249	22,500	21,206	6000	37,806	9,026	56,709
1000	91,495	21,843	22,874	6500	35,225	8,409	57,240
1100	88,949	21,235	24,461	7000	32,827	7,837	57,447
1200	86,583	20,670	25,975	7500	30,589	7,303	57,354
1300	84,372	20,142	27,421	8000	28,490	6,802	56,980
1400	82,297	19,647	28,804	8500	26,515	6,330	56,344
1500	80,343	19,180	30,128	9000	24,649	5,884	55,460
1600	78,495	18,739	31,398	9500	22,881	5,462	54,342
1700	76,745	18,321	32,616	10000	21,201	5,061	53,003
1800	75,080	17,924	33,786				
1900	73,494	17,545	34,910				

Rotational speeds over 10000 rpm and/or belt speeds over 50 m/s need special drive designs. Please ask for our advice.

2. Tension member strength (permitted tensile force of the belt F_{zul}), Belt weight

Belt width	b	[mm]	25	32	50	75	100	150
Tension member strength F _{zul}		[N]	4950	6750	11250	17550	23850	36450
Belt weight	ATP 15	[kg/m]	0,200	0,256	0,400	0,600	0,800	1,200

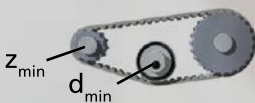
3. Flexibility (Minimum numbers of teeth, minimum diameter)

Timing pulley	z _{min}	20		Drive type without contraflexure
Tension roller (smooth), running on teeth	d _{min} [mm]	100		
Timing pulley	z _{min}	30		Drive type with contraflexure
Tension roller (smooth), running on the back of the belt	d _{min} [mm]	60		

AT high performance Timing Belts

AT 20 GEN III

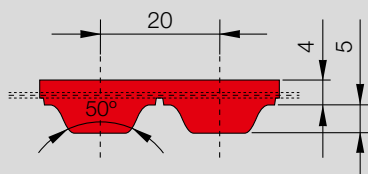

CONTI® SYNCHROFLEX Timing Belt (SFX) AT 20 GEN III

High performance AT profile with metric pitches and trapezoidal teeth.

Standard version:

- single-sided
- high performance polyurethane in red colour
- steel cord tension members with high density
- steel cord tension members in two-filament construction

Type / Length* GEN III	Number of teeth	Type / Length* GEN III	Number of teeth
AT 20 / 1000**	50	AT 20 / 1960**	98
AT 20 / 1100	55		
AT 20 / 1200**	60		
AT 20 / 1260	63		
AT 20 / 1500**	75		
AT 20 / 1600**	80		
AT 20 / 1700	85		
AT 20 / 1760**	88		
AT 20 / 1800	90		
AT 20 / 1900**	95		

Preferred belt width* in mm:
32, 50, 75, 100

* Other dimensions upon request.
** In combination with reduced pulley gap please ask for technical support from your Mulco sales partner.

Order example

CONTI® SYNCHROFLEX Timing Belt 32 AT20/1000 GEN III

Belt width in mm _____

Type/Pitch _____

Belt length in mm _____

Specification Generation III _____

AT 20 GEN III Technical data

1. Tooth shear strength (specific belt tooth strength)

R.p.m. n [min ⁻¹]	F _{Uspec} [N/cm]	M _{spec} [Ncm/cm]	P _{spec} [W/cm]	R.p.m. n [min ⁻¹]	F _{Uspec} [N/cm]	M _{spec} [Ncm/cm]	P _{spec} [W/cm]
0	201,93	64,28	0,00	2000	91,72	29,19	61,14
20	198,34	63,13	1,32	2200	87,39	27,82	64,08
40	194,82	62,01	2,60	2400	83,40	26,55	66,71
60	191,52	60,96	3,83	2600	79,70	25,37	69,07
80	188,43	59,98	5,02	2800	76,25	24,27	71,16
100	185,51	59,05	6,18	3000	73,01	23,24	73,01
200	172,99	55,07	11,53	3200	69,97	22,27	74,63
300	162,95	51,87	16,29	3400	67,10	21,36	76,05
400	154,56	49,20	20,61	3600	64,39	20,50	77,26
500	147,36	46,91	24,56	3800	61,81	19,67	78,28
600	141,05	44,90	28,21	4000	59,35	18,89	79,13
700	135,43	43,11	31,60	4500	53,69	17,09	80,52
800	130,37	41,50	34,76	5000	48,59	15,47	80,97
900	125,77	40,03	37,73	5500	43,95	13,99	80,57
1000	121,55	38,69	40,51	6000	39,70	12,64	79,40
1100	117,65	37,45	43,13	6500	35,78	11,39	77,51
1200	114,03	36,30	45,61				
1300	110,64	35,22	47,94				
1400	107,47	34,21	50,15				
1500	104,48	33,26	52,24				
1600	101,66	32,36	54,22				
1700	98,99	31,51	56,09				
1800	96,45	30,70	57,87				
1900	94,03	29,93	59,55				

Rotational speeds over 6500 rpm and/or belt speeds over 40 m/s need special drive designs. Please ask for our advice.

2. Tension member strength (permitted tensile force of the belt F_{zul}), Belt weight

Belt width	b	[mm]	25	32	50	75	100	150
Tension member strength F _{zul}		[N]	6300	8550	13950	21600	28800	44100
Belt weight	AT 20 GEN III	[kg/m]	0,290	0,371	0,583	0,87	1,16	1,74

3. Flexibility (Minimum numbers of teeth, minimum diameter)

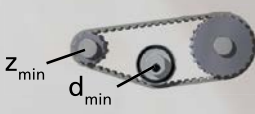
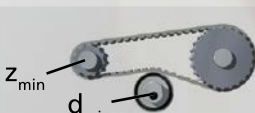
Timing pulley	Z _{min}	18		Drive type without contraflexure
Tension roller (smooth), running on teeth	d _{min} [mm]	120		
Timing pulley	Z _{min}	25		Drive type with contraflexure
Tension roller (smooth), running on the back of the belt	d _{min} [mm]	180		

AT high performance Timing Belts

AT 20

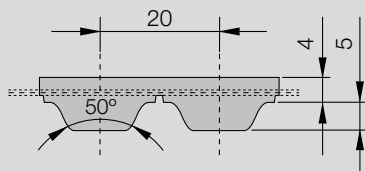

CONTI® SYNCHROFLEX Timing Belt (SFX) AT 20

High performance AT profile with metric pitches and trapezoidal teeth.

The technical data refer to standard polyurethane and standard steel cord tension members.

Available versions:

- single-sided
- polyurethane special materials upon request
- antistatic, coloured, mechanical reworked

Type / Length*	Number of teeth	Type / Length*	Number of teeth
AT 20 / 1000**	50	AT 20 / 1960**	98
AT 20 / 1100	55		
AT 20 / 1200**	60		
AT 20 / 1260	63		
AT 20 / 1500**	75		
AT 20 / 1600**	80		
AT 20 / 1700	85		
AT 20 / 1760**	88		
AT 20 / 1800	90		
AT 20 / 1900**	95		

Preferred belt width* in mm:
32, 50, 75, 100

* Other dimensions upon request.

** In combination with reduced pulley gap please ask for technical support from your Mulco sales partner.

Order example

CONTI® SYNCHROFLEX Timing Belt 50 AT20/1500

Belt width in mm _____

Type/Pitch _____

Belt length in mm _____

AT 20 Technical data

1. Tooth shear strength (specific belt tooth strength)

R.p.m. n [min ⁻¹]	F _{Uspec} [N/cm]	M _{spec} [Ncm/cm]	P _{spec} [W/cm]
0	161,54	51,42	0,00
20	158,67	50,51	1,06
40	155,85	49,61	2,08
60	153,22	48,77	3,06
80	150,74	47,98	4,02
100	148,41	47,24	4,95
200	138,40	44,05	9,23
300	130,36	41,50	13,04
400	123,65	39,36	16,49
500	117,89	37,52	19,65
600	112,84	35,92	22,57
700	108,35	34,49	25,28
800	104,30	33,20	27,81
900	100,62	32,03	30,18
1000	97,24	30,95	32,41
1100	94,12	29,96	34,51
1200	91,22	29,04	36,49
1300	88,51	28,18	38,35
1400	85,98	27,37	40,12
1500	83,59	26,61	41,79
1600	81,33	25,89	43,37
1700	79,19	25,21	44,87
1800	77,16	24,56	46,29
1900	75,22	23,94	47,64



R.p.m. n [min ⁻¹]	F _{Uspec} [N/cm]	M _{spec} [Ncm/cm]	P _{spec} [W/cm]
2000	73,37	23,36	48,91
2200	69,91	22,25	51,26
2400	66,72	21,24	53,37
2600	63,76	20,29	55,25
2800	61,00	19,42	56,93
3000	58,41	18,59	58,41
3200	55,98	17,82	59,71
3400	53,68	17,09	60,84
3600	51,51	16,40	61,81
3800	49,45	15,74	62,63
4000	47,48	15,11	63,31
4500	42,95	13,67	64,42
5000	38,87	12,37	64,78
5500	35,16	11,19	64,46
6000	31,76	10,11	63,52
6500	28,62	9,11	62,01

Rotational speeds over 6500 rpm and/or belt speeds over 40 m/s need special drive designs. Please ask for our advice.

2. Tension member strength (permitted tensile force of the belt F_{zul}), Belt weight

Belt width	b	[mm]	32	50	75	100	150
Tension member strength F _{zul}		[N]	6750	11250	17550	23850	36450
Belt weight	AT 20	[kg/m]	0,339	0,530	0,795	1,060	1,590

3. Flexibility (Minimum numbers of teeth, minimum diameter)

Timing pulley	Z _{min}	18		Drive type without contraflexure
Tension roller (smooth), running on teeth	d _{min} [mm]	120		
Timing pulley	Z _{min}	25		Drive type with contraflexure
Tension roller (smooth), running on the back of the belt	d _{min} [mm]	180		

T standard Timing Belts

T 2

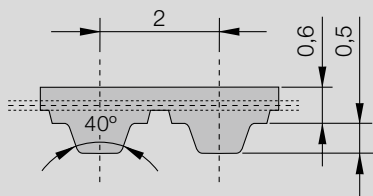

CONTI® SYNCHROFLEX Timing Belt (SFX) T 2

Standard T profile with metric pitch and trapezoidal teeth.

The technical data refer to standard polyurethane and standard steel cord tension members.

Available versions:

- single-sided
- with Aramide tension member
- polyurethane special materials upon request
- antistatic, coloured, mechanical reworked

FA: with bigger back thickness

FN: with profiles on the back of the belt

Type / Length*	Number of teeth	Type / Length*	Number of teeth
T 2 / 68	34	T 2 / 220 FN2	110
T 2 / 90	45	T 2 / 240	120
T 2 / 108	54	T 2 / 256	128
T 2 / 118	59	T 2 / 262	131
T 2 / 120	60	T 2 / 280	140
T 2 / 120 FA	60	T 2 / 292	146
T 2 / 138	69	T 2 / 320	160
T 2 / 140	70	T 2 / 360	180
T 2 / 144	72	T 2 / 600	300
T 2 / 150	75	T 2 / 710	355
T 2 / 160	80	T 2 / 710 FA	355
T 2 / 180	90	T 2 / 1296 FA	648
T 2 / 200	100		
T 2 / 220	110		
T 2 / 220 FA	110		

Preferred belt width* in mm:
4, 6, 10

* Other dimensions upon request.

Order example

CONTI® SYNCHROFLEX Timing Belt 6 T2/240

Belt width in mm _____

Type/Pitch _____

Belt length in mm _____

T 2 Technical data

1. Tooth shear strength (specific belt tooth strength)



R.p.m. n [min ⁻¹]	F _{Uspec} [N/cm]	M _{spec} [Ncm/cm]	P _{spec} [W/cm]	R.p.m. n [min ⁻¹]	F _{Uspec} [N/cm]	M _{spec} [Ncm/cm]	P _{spec} [W/cm]
0	6,58	0,209	0,000	2400	3,42	0,109	0,274
20	6,36	0,202	0,004	2500	3,39	0,108	0,282
40	6,18	0,197	0,008	2600	3,35	0,107	0,290
60	6,03	0,192	0,012	2800	3,29	0,105	0,307
80	5,90	0,188	0,016	2880	3,26	0,104	0,313
100	5,79	0,184	0,019	3000	3,23	0,103	0,323
150	5,56	0,177	0,028	3200	3,17	0,101	0,338
200	5,38	0,171	0,036	3400	3,12	0,099	0,354
300	5,10	0,162	0,051	3600	3,07	0,098	0,368
400	4,89	0,156	0,065	3800	3,02	0,096	0,383
500	4,72	0,150	0,079	4000	2,98	0,095	0,397
600	4,58	0,146	0,092	4500	2,88	0,092	0,432
700	4,45	0,142	0,104	5000	2,78	0,088	0,463
730	4,42	0,141	0,108	5500	2,70	0,086	0,495
800	4,35	0,138	0,116	6000	2,63	0,084	0,526
900	4,25	0,135	0,127	6500	2,56	0,081	0,555
1000	4,16	0,132	0,139	7000	2,49	0,079	0,581
1100	4,08	0,130	0,150	7500	2,43	0,077	0,607
1200	4,01	0,128	0,160	8000	2,37	0,075	0,632
1300	3,94	0,125	0,171	8500	2,32	0,074	0,657
1400	3,88	0,124	0,181	9000	2,27	0,072	0,681
1460	3,85	0,123	0,187	9500	2,22	0,071	0,703
1500	3,82	0,122	0,191	10000	2,18	0,069	0,727
1600	3,77	0,120	0,201	12000	2,02	0,064	0,808
1700	3,72	0,118	0,211	15000	1,82	0,058	0,910
1800	3,67	0,117	0,220	18000	1,66	0,053	0,996
1900	3,62	0,115	0,229	20000	1,57	0,050	1,047
2000	3,58	0,114	0,239				
2200	3,50	0,111	0,257				

Rotational speeds over 20000 rpm and/or belt speeds over 80 m/s need special drive designs. Please ask for our advice.

2. Tension member strength (permitted tensile force of the belt F_{zul}), Belt weight

Belt width	b	[mm]	4	6	10	16	25	32
Tension member strength F _{zul}		[N]	39	65	117	195	312	403
Belt weight	T 2	[kg/m]	0,004	0,007	0,011	0,018	0,028	0,035

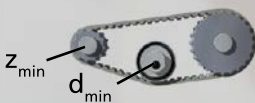
3. Flexibility (Minimum numbers of teeth, minimum diameter)

Timing pulley	Z _{min}	10		Drive type without contraflexure
Tension roller (smooth), running on teeth	d _{min} [mm]	15		
Timing pulley	Z _{min}	18		Drive type with contraflexure
Tension roller (smooth), running on the back of the belt	d _{min} [mm]	15		

T standard Timing Belts

T 2,5 / T 2,5-DL

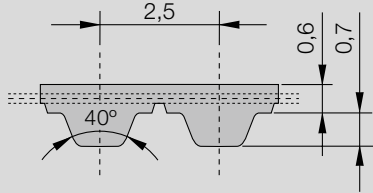

CONTI® SYNCHROFLEX Timing Belt (SFX) T 2,5

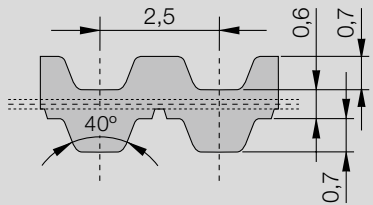

CONTI® SYNCHROFLEX Timing Belt (SFX) T 2,5-DL

Standard T profile according to DIN 7721 with metric pitch and trapezoidal teeth.

The technical data refer to standard polyurethane and standard steel cord tension members.

Available versions:

- single-sided (as standard)
- with Aramide tension member
- polyurethane special materials upon request
- antistatic, coloured, mechanical reworked

DL: double-sided

FA: with bigger back thickness

FN: with profiles on the back of the belt

Type / Length*	Number of teeth	Type / Length*	Number of teeth
T 2,5 / 55 FA	22	T 2,5 / 317,5 DL	127
T 2,5 / 75 FN2	30	T 2,5 / 330	132
T 2,5 / 120	48	T 2,5 / 380	152
T 2,5 / 145	58	T 2,5 / 395	158
T 2,5 / 160	64	T 2,5 / 400 FA	160
T 2,5 / 160 FA	64	T 2,5 / 415 DL	166
T 2,5 / 177,5	71	T 2,5 / 420	168
T 2,5 / 180	72	T 2,5 / 420 FN168	168
T 2,5 / 182,5	73	T 2,5 / 457,5 DL	183
T 2,5 / 200	80	T 2,5 / 480	192
T 2,5 / 210 FA	84	T 2,5 / 500	200
T 2,5 / 210 FN28	84	T 2,5 / 500 FA	200
T 2,5 / 220 FN3	88	T 2,5 / 540	216
T 2,5 / 225	90	T 2,5 / 540 FA	216
T 2,5 / 230	92	T 2,5 / 600 FA	240
T 2,5 / 230 FA	92	T 2,5 / 620	248
T 2,5 / 245	98	T 2,5 / 650	260
T 2,5 / 250	100	T 2,5 / 650 FN2	260
T 2,5 / 265	106	T 2,5 / 780	312
T 2,5 / 285	114	T 2,5 / 780 FA	312
T 2,5 / 285 FA	114	T 2,5 / 950	380
T 2,5 / 290	116	T 2,5 / 1300	520
T 2,5 / 305	122	T 2,5 / 1300 FA	520
T 2,5 / 305 FA	122	T 2,5 / 1350 FA	540
T 2,5 / 305 FN1	122	T 2,5 / 1475 FA	590
T 2,5 / 317,5	127		

Preferred belt width* in mm:
4, 6, 10

* Other dimensions upon request.

Order example

CONTI® SYNCHROFLEX Timing Belt 10 T2,5/380

Belt width in mm _____

Type/Pitch _____

Belt length in mm _____

T 2,5 / T 2,5-DL Technical data

1. Tooth shear strength (specific belt tooth strength)



R.p.m. n [min ⁻¹]	F _{Uspec} [N/cm]	M _{spec} [Ncm/cm]	P _{spec} [W/cm]	R.p.m. n [min ⁻¹]	F _{Uspec} [N/cm]	M _{spec} [Ncm/cm]	P _{spec} [W/cm]
0	9,03	0,359	0,000	2500	4,65	0,185	0,484
20	8,72	0,347	0,007	2600	4,60	0,183	0,499
40	8,48	0,337	0,014	2800	4,51	0,180	0,527
60	8,28	0,329	0,021	2880	4,48	0,178	0,538
80	8,10	0,322	0,027	3000	4,43	0,176	0,554
100	7,95	0,316	0,033	3200	4,36	0,173	0,581
150	7,64	0,304	0,048	3400	4,28	0,170	0,607
200	7,39	0,294	0,062	3600	4,22	0,168	0,632
300	7,01	0,279	0,088	3800	4,15	0,165	0,657
400	6,71	0,267	0,112	4000	4,09	0,163	0,682
500	6,48	0,258	0,135	4500	3,95	0,157	0,740
600	6,28	0,250	0,157	5000	3,82	0,152	0,796
700	6,11	0,243	0,178	5500	3,71	0,148	0,850
730	6,07	0,241	0,185	6000	3,60	0,143	0,901
800	5,97	0,237	0,199	6500	3,51	0,140	0,950
900	5,83	0,232	0,219	7000	3,42	0,136	0,997
1000	5,71	0,227	0,238	7500	3,33	0,133	1,042
1100	5,61	0,223	0,257	8000	3,26	0,130	1,086
1200	5,51	0,219	0,275	8500	3,18	0,127	1,128
1300	5,41	0,215	0,293	9000	3,11	0,124	1,168
1400	5,33	0,212	0,311	9500	3,05	0,121	1,207
1460	5,28	0,210	0,321	10000	2,99	0,119	1,245
1500	5,25	0,209	0,328	12000	2,77	0,110	1,384
1600	5,17	0,206	0,345	15000	2,50	0,099	1,561
1700	5,10	0,203	0,361	18000	2,28	0,091	1,708
1800	5,04	0,200	0,378	20000	2,15	0,086	1,791
1900	4,97	0,198	0,394				
2000	4,91	0,195	0,409				
2200	4,80	0,191	0,440				
2400	4,70	0,187	0,470				

Rotational speeds over 20000 rpm and/or belt speeds over 80 m/s need special drive designs. Please ask for our advice.

2. Tension member strength (permitted tensile force of the belt F_{zul}), Belt weight

Belt width	b	[mm]	4	6	10	16	25	32
Tension member strength F _{zul}		[N]	39	65	117	195	312	403
Belt weight	T 2,5	[kg/m]	0,006	0,009	0,015	0,024	0,038	0,048
	T 2,5-DL	[kg/m]	0,006	0,009	0,016	0,025	0,040	0,051

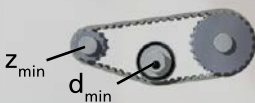
3. Flexibility (Minimum numbers of teeth, minimum diameter)

Timing pulley	Z _{min}	10		Drive type without contraflexure
Tension roller (smooth), running on teeth	d _{min} [mm]	15		
Timing pulley	Z _{min}	18		Drive type with contraflexure
Tension roller (smooth), running on the back of the belt	d _{min} [mm]	15		

T standard Timing Belts

T 5 / T 5-DL

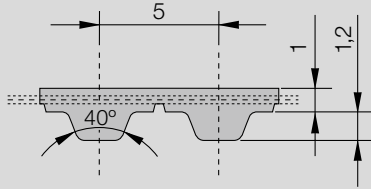

CONTI® SYNCHROFLEX Timing Belt (SFX) T 5

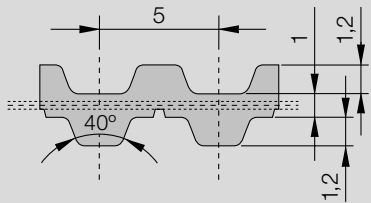

CONTI® SYNCHROFLEX Timing Belt (SFX) T 5-DL

Standard T profile according to DIN 7721 with metric pitch and trapezoidal teeth.

The technical data refer to standard polyurethane and standard steel cord tension members.

Available versions:

- single-sided (as standard)
- with "E" tension member for a better flexibility
- with Aramide tension member
- polyurethane special materials upon request
- antistatic, coloured, mechanical reworked

DL: double-sided

FA: with bigger back thickness

FN: with profiles on the back of the belt

Order example

CONTI® SYNCHROFLEX Timing Belt 10 T5/455

Belt width in mm _____

Type/Pitch _____

Belt length in mm _____

Type / Length*	Number of teeth	Type / Length*	Number
T 5 / 100	20	T 5 / 590 DL	118
T 5 / 150	30	T 5 / 600 FN	120
T 5 / 150 DL	30	T 5 / 610	122
T 5 / 165	33	T 5 / 615 FN	123
T 5 / 165 FN33	33	T 5 / 620	124
T 5 / 180	36	T 5 / 620 DL	124
T 5 / 185	37	T 5 / 625 DL	125
T 5 / 200	40	T 5 / 630	126
T 5 / 210	42	T 5 / 630 FA	126
T 5 / 215	43	T 5 / 650	130
T 5 / 220	44	T 5 / 650 FA	130
T 5 / 225	45	T 5 / 660	132
T 5 / 225 FN90	45	T 5 / 660 FN30	132
T 5 / 245	49	T 5 / 690	138
T 5 / 250	50	T 5 / 690 FA	138
T 5 / 255	51	T 5 / 690 FN3	138
T 5 / 260	52	T 5 / 700	140
T 5 / 260 DL	52	T 5 / 720	144
T 5 / 260 FN1	52	T 5 / 725	145
T 5 / 270	54	T 5 / 750	150
T 5 / 280	56	T 5 / 750 DL	150
T 5 / 295	59	T 5 / 765	153
T 5 / 300 DL	60	T 5 / 780	156
T 5 / 305	61	T 5 / 800	160
T 5 / 330	66	T 5 / 800 FN2	160
T 5 / 330 DL	66	T 5 / 815	163
T 5 / 340	68	T 5 / 815 DL	163
T 5 / 340 FN6	68	T 5 / 840	168
T 5 / 355	71	T 5 / 840 FN	168
T 5 / 365	73	T 5 / 860 FN1	172
T 5 / 390	78	T 5 / 860 DL	172
T 5 / 390 FN1	78	T 5 / 900	180
T 5 / 400	80	T 5 / 920	184
T 5 / 410	82	T 5 / 925	185
T 5 / 410 DL	82	T 5 / 925 FN1	185
T 5 / 420	84	T 5 / 940	188
T 5 / 455	91	T 5 / 940 DL	188
T 5 / 460	92	T 5 / 990	198
T 5 / 460 FN4	92	T 5 / 990 FN4	198
T 5 / 460 DL	92	T 5 / 1075	215
T 5 / 480	96	T 5 / 1075 FA	215
T 5 / 500	100	T 5 / 1100	220
T 5 / 500 FN10	100	T 5 / 1100 DL	220
T 5 / 505	101	T 5 / 1100 FN22	220
T 5 / 510	102	T 5 / 1140 FN1	228
T 5 / 510 FN1	102	T 5 / 1160	232
T 5 / 515 DL	103	T 5 / 1215	243
T 5 / 525	105	T 5 / 1215 FN	243
T 5 / 525 FA	105	T 5 / 1315	263
T 5 / 525 DL	105	T 5 / 1325 DL	265
T 5 / 545	109	T 5 / 1350 FN1	270
T 5 / 550	110	T 5 / 1380	276
T 5 / 560	112	T 5 / 1380 FN1	276
T 5 / 575	115	T 5 / 1500	300
T 5 / 590	118		

Preferred belt width* in mm:
6, 10, 16, 25, 50

* Other dimensions upon request.

T 5 / T 5-DL Technical data

1. Tooth shear strength (specific belt tooth strength)



R.p.m. n [min ⁻¹]	F _{Uspec} [N/cm]	M _{spec} [Ncm/cm]	P _{spec} [W/cm]	R.p.m. n [min ⁻¹]	F _{Uspec} [N/cm]	M _{spec} [Ncm/cm]	P _{spec} [W/cm]
0	24,00	1,910	0,000	2000	13,69	1,089	2,28
20	23,40	1,861	0,039	2200	13,38	1,065	2,45
40	22,90	1,819	0,076	2400	13,10	1,042	2,62
60	22,40	1,783	0,112	2600	12,84	1,021	2,78
80	22,00	1,751	0,147	2800	12,59	1,002	2,94
100	21,70	1,723	0,180	3000	12,37	0,984	3,09
200	20,30	1,614	0,338	3200	12,16	0,967	3,24
300	19,30	1,536	0,483	3400	11,96	0,951	3,39
400	18,55	1,476	0,618	3600	11,77	0,936	3,53
500	17,93	1,427	0,747	3800	11,59	0,922	3,67
600	17,41	1,385	0,870	4000	11,42	0,909	3,81
700	16,96	1,349	0,989	4500	11,03	0,878	4,14
800	16,56	1,318	1,104	5000	10,68	0,850	4,45
900	16,20	1,289	1,215	5500	10,36	0,825	4,75
1000	15,88	1,263	1,323	6000	10,07	0,802	5,04
1100	15,58	1,240	1,428	6500	9,81	0,780	5,31
1200	15,31	1,218	1,531	7000	9,56	0,761	5,58
1300	15,06	1,198	1,632	7500	9,33	0,742	5,83
1400	14,83	1,180	1,730	8000	9,11	0,725	6,08
1500	14,61	1,162	1,826	8500	8,91	0,709	6,31
1600	14,40	1,146	1,920	9000	8,72	0,694	6,54
1700	14,21	1,131	2,010	9500	8,54	0,679	6,76
1800	14,03	1,116	2,100	10000	8,37	0,666	6,97
1900	13,85	1,102	2,190				

Rotational speeds over 10000 rpm and/or belt speeds over 80 m/s need special drive designs. Please ask for our advice.

2. Tension member strength (permitted tensile force of the belt F_{zul}), Belt weight

Belt width	b	[mm]	6	10	16	25	32	50	75	100
Tension member strength F _{zul}		[N]	180	330	570	930	1200	1920	2940	3930
Belt weight	T 5	[kg/m]	0,014	0,024	0,038	0,060	0,077	0,120	0,180	0,240
	T 5-DL	[kg/m]	0,016	0,027	0,043	0,067	0,086	0,135	0,203	0,270

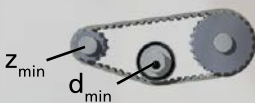
3. Flexibility (Minimum numbers of teeth, minimum diameter)

Timing pulley	z _{min}	10		Drive type without contraflexure
Tension roller (smooth), running on teeth	d _{min} [mm]	30		
Timing pulley	z _{min}	15		Drive type with contraflexure
Tension roller (smooth), running on the back of the belt	d _{min} [mm]	30		

T standard Timing Belts

T 10 / T 10-DL

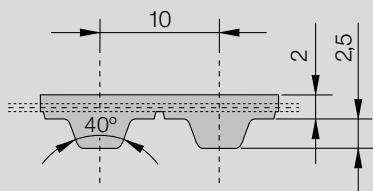

CONTI® SYNCHROFLEX Timing Belt (SFX) T 10

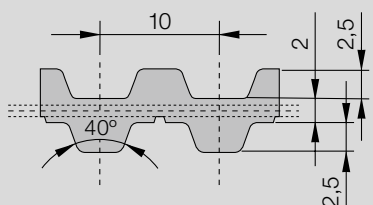

CONTI® SYNCHROFLEX Timing Belt T (SFX) 10-DL

Standard T profile according to DIN 7721 with metric pitch and trapezoidal teeth.

The technical data refer to standard polyurethane and standard steel cord tension members.

Available version

- single-sided (as standard)
- with "E" tension member for a better flexibility
- with Aramide tension member
- polyurethane special materials upon request
- antistatic, coloured, mechanical reworked

DL: double-sided

FA: with bigger back thickness

FN: with profiles on the back of the belt

Order example

CONTI® SYNCHROFLEX Timing Belt 16 T10/260

Belt width in mm _____

Type/Pitch _____

Belt length in mm _____

Type / Length*	Number of teeth	Type / Length*	Number of teeth
T 10 / 260	26	T 10 / 980	98
T 10 / 260 DL	26	T 10 / 980 DL	98
T 10 / 350	35	T 10 / 1010	101
T 10 / 370	37	T 10 / 1080	108
T 10 / 400	40	T 10 / 1110	111
T 10 / 410	41	T 10 / 1140	114
T 10 / 410 FA	41	T 10 / 1150	115
T 10 / 420 FN21	42	T 10 / 1210	121
T 10 / 440	44	T 10 / 1210 DL	121
T 10 / 450	45	T 10 / 1240	124
T 10 / 500	50	T 10 / 1240 DL	124
T 10 / 500 FN	50	T 10 / 1250	125
T 10 / 530	53	T 10 / 1250 DL	125
T 10 / 530 DL	53	T 10 / 1300	130
T 10 / 560	56	T 10 / 1320	132
T 10 / 600	60	T 10 / 1320 DL	132
T 10 / 610	61	T 10 / 1350	135
T 10 / 630	63	T 10 / 1350 DL	135
T 10 / 630 DL	63	T 10 / 1390	139
T 10 / 660	66	T 10 / 1400	140
T 10 / 660 DL	66	T 10 / 1420	142
T 10 / 680	68	T 10 / 1420 DL	142
T 10 / 690	69	T 10 / 1450	145
T 10 / 700	70	T 10 / 1460	146
T 10 / 720	72	T 10 / 1460 FN146	146
T 10 / 720 DL	72	T 10 / 1500	150
T 10 / 730	73	T 10 / 1560	156
T 10 / 750	75	T 10 / 1610	161
T 10 / 760	76	T 10 / 1610 DL	161
T 10 / 780	78	T 10 / 1750	175
T 10 / 780 FN78	78	T 10 / 1780	178
T 10 / 800 FN80	80	T 10 / 1800 FN12	180
T 10 / 810	81	T 10 / 1880	188
T 10 / 840	84	T 10 / 1880 DL	188
T 10 / 840 DL	84	T 10 / 1960	196
T 10 / 840 FN84	84	T 10 / 2250	225
T 10 / 850	85	T 10 / 3100	310
T 10 / 880	88	T 10 / 4780	478
T 10 / 890	89	T 10 / 4780 DL**	478
T 10 / 920	92		
T 10 / 960	96		
T 10 / 970	97		
T 10 / 970 FN97	97		

Preferred belt width* in mm:
16, 25, 32, 50

* Other dimensions upon request.
** Please request technical support from your Mulco sales partner.

T 10 / T 10-DL Technical data

1. Tooth shear strength (specific belt tooth strength)



R.p.m. n [min ⁻¹]	F _{Uspec} [N/cm]	M _{spec} [Ncm/cm]	P _{spec} [W/cm]	R.p.m. n [min ⁻¹]	F _{Uspec} [N/cm]	M _{spec} [Ncm/cm]	P _{spec} [W/cm]
0	50,5	8,04	0,000	2000	25,40	4,04	8,46
20	49,0	7,80	0,163	2200	24,60	3,92	9,03
40	47,7	7,60	0,318	2400	23,90	3,81	9,58
60	46,6	7,42	0,466	2600	23,30	3,71	10,10
80	45,7	7,27	0,609	2800	22,70	3,62	10,60
100	44,8	7,13	0,746	3000	22,20	3,53	11,08
200	41,4	6,60	1,381	3200	21,70	3,45	11,55
300	39,1	6,22	1,953	3400	21,20	3,36	11,99
400	37,2	5,92	2,480	3600	20,70	3,30	12,42
500	35,7	5,68	2,980	3800	20,30	3,23	12,84
600	34,4	5,48	3,440	4000	19,86	3,16	13,24
700	33,3	5,31	3,890	4500	18,91	3,01	14,18
800	32,4	5,15	4,320	5000	18,06	2,87	15,05
900	31,5	5,01	4,730	5500	17,28	2,75	15,84
1000	30,7	4,89	5,120	6000	16,58	2,64	16,58
1100	30,0	4,77	5,500	6500	15,93	2,54	17,26
1200	29,3	4,67	5,870	7000	15,33	2,44	17,88
1300	28,7	4,57	6,220	7500	14,76	2,35	18,46
1400	28,2	4,48	6,570	8000	14,24	2,27	18,99
1500	27,6	4,40	6,910	8500	13,74	2,18	19,47
1600	27,1	4,32	7,230	9000	13,28	2,11	19,92
1700	26,7	4,24	7,550	9500	12,84	2,04	20,30
1800	26,2	4,17	7,860	10000	12,42	1,97	20,70
1900	25,8	4,10	8,160				

Rotational speeds over 10000 rpm and/or belt speeds over 60 m/s need special drive designs. Please ask for our advice.

2. Tension member strength (permitted tensile force of the belt F_{zul}), Belt weight

Belt width	b	[mm]	16	25	32	50	75	100	150
Tension member strength F _{zul}		[N]	1200	2000	2700	4300	6600	8800	13400
Belt weight	T 10	[kg/m]	0,077	0,120	0,154	0,240	0,360	0,480	0,720
	T 10-DL	[kg/m]	0,091	0,143	0,182	0,285	0,428	0,570	0,855

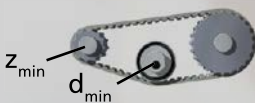
3. Flexibility (Minimum numbers of teeth, minimum diameter)

Timing pulley	z _{min}	12		Drive type without contraflexure
Tension roller (smooth), running on teeth	d _{min} [mm]	60		
Timing pulley	z _{min}	20		Drive type with contraflexure
Tension roller (smooth), running on the back of the belt	d _{min} [mm]	60		

T standard Timing Belts

T 20 / T 20-DL

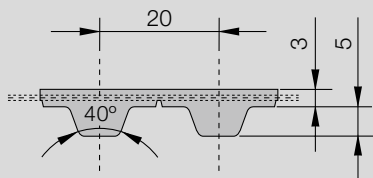

CONTI® SYNCHROFLEX Timing Belt (SFX) T 20

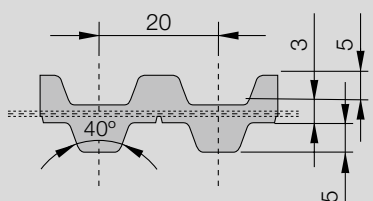

CONTI® SYNCHROFLEX Timing Belt (SFX) T 20-DL

Standard T profile according to DIN 7721 with metric pitch and trapezoidal teeth.

The technical data refer to standard polyurethane and standard steel cord tension members.

Available versions:

- single-sided (as standard)
- with "E" tension member for a better flexibility
- with Aramide tension member (except DL)
- polyurethane special materials upon request
- antistatic, coloured, mechanical reworked

DL: double-sided

Type / Length*	Number of teeth
T 20 / 1260	63
T 20 / 1460	73
T 20 / 1780	89
T 20 / 1880	94
T 20 / 2600	130

Type / Length*	Number of teeth
T 20 / 2600 DL**	130
T 20 / 3100	155
T 20 / 3620	181
T 20 / 3620 DL**	181

Preferred belt width* in mm:
32, 50, 75, 100

* Other dimensions upon request.
** In combination with reduced pulley gap please ask for technical support from your Mulco sales partner.

Order example

CONTI® SYNCHROFLEX Timing Belt **50 T20/2600**

Belt width in mm _____

Type/Pitch _____

Belt length in mm _____

T 20 / T 20-DL Technical data

1. Tooth shear strength (specific belt tooth strength)



R.p.m. n [min ⁻¹]	F _{Uspec} [N/cm]	M _{spec} [Ncm/cm]	P _{spec} [W/cm]	R.p.m. n [min ⁻¹]	F _{Uspec} [N/cm]	M _{spec} [Ncm/cm]	P _{spec} [W/cm]
0	101,5	32,30	0,000	2000	45,3	14,42	30,2
20	98,1	31,20	0,654	2200	43,6	13,89	32,0
40	95,3	30,30	1,271	2400	42,1	13,40	33,7
60	92,8	29,50	1,856	2600	40,7	12,95	35,2
80	90,7	28,90	2,420	2800	39,4	12,53	36,7
100	88,7	28,20	2,960	3000	38,1	12,13	38,1
200	81,2	25,90	5,420	3200	37,0	11,77	39,4
300	75,9	24,20	7,590	3400	35,9	11,42	40,7
400	71,8	22,90	9,570	3600	34,9	11,09	41,8
500	68,4	21,80	11,410	3800	33,9	10,78	42,9
600	65,6	20,90	13,110	4000	33,0	10,49	43,9
700	63,1	20,10	14,730	4500	30,8	9,81	46,2
800	60,9	19,40	16,250	5000	28,9	9,21	48,2
900	59,0	18,78	17,700	5500	27,2	8,66	49,9
1000	57,2	18,22	19,080	6000	25,6	8,16	51,2
1100	55,6	17,71	20,400	6500	24,2	7,69	52,4
1200	54,2	17,24	21,700				
1300	52,8	16,80	22,900				
1400	51,5	16,40	24,000				
1500	50,3	16,02	25,200				
1600	49,2	15,66	26,200				
1700	48,2	15,33	27,300				
1800	47,2	15,01	28,300				
1900	46,2	14,71	29,300				

Rotational speeds over 6500 rpm and/or belt speeds over 40 m/s need special drive designs. Please ask for our advice.

2. Tension member strength (permitted tensile force of the belt F_{zul}), Belt weight

Belt width	b	[mm]	32	50	75	100	150
Tension member strength F _{zul}		[N]	4750	7750	12000	16000	24500
Belt weight	T 20	[kg/m]	0,269	0,420	0,630	0,840	1,260
	T 20-DL	[kg/m]	0,355	0,555	0,833	1,110	1,665

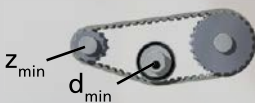
3. Flexibility (Minimum numbers of teeth, minimum diameter)

Timing pulley	Z _{min}	15		Drive type without contraflexure
Tension roller (smooth), running on teeth	d _{min} [mm]	120		
Timing pulley	Z _{min}	25		Drive type with contraflexure
Tension roller (smooth), running on the back of the belt	d _{min} [mm]	120		

Imperial Timing Belts

M (MXL)

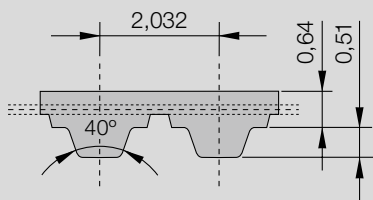

CONTI® SYNCHROFLEX Timing Belt (SFX) M (MXL)

Standard trapezoidal teeth according to DIN/ISO 5296 with Minipitch (2.032 mm = 0.08 Inch).

The technical data refer to standard polyurethane and standard steel cord tension members.

Available versions:

- single-sided
- with Aramide tension member
- polyurethane special materials upon request
- antistatic, coloured, mechanical reworked

FA: with bigger back thickness

FN: with profiles on the back of the belt

Type / Length*	Number of teeth	Type / Length*	Number of teeth
M 111 / 111,76	55	M 264 / 264,16	130
M 113 / 113,79	56	M 284 / 284,48	140
M 121 / 121,92	60	M 304 / 304,80	150
M 121 / 121,92 FA	60	M 355 / 355,60	175
M 132 / 132,08	65	M 373 / 373,89	184
M 142 / 142,24	70	M 449 / 449,07	221
M 144 / 144,27	71	M 503 / 503,94	248
M 162 / 162,56	80	M 508 / 508,00 FN	250
M 182 / 182,88	90	M 520 / 520,19	256
M 197 / 197,10	97	M 599 / 599,44	295
M 203 / 203,20	100	M 731 / 731,52	360
M 209 / 209,30	103	M1178 / 1178,56	580
M 213 / 213,36	105		
M 243 / 243,86	120		
M 256 / 256,03	126		

Preferred belt width* in mm:
4, 6, 10

* Other dimensions upon request.

Order example

CONTI® SYNCHROFLEX Timing Belt 6 M / 182

Belt width in mm _____

Type/Pitch _____

Belt length in mm _____

M (MXL) Technical data

1. Tooth shear strength (specific belt tooth strength)

R.p.m. n [min ⁻¹]	F _{Uspec} [N/cm]	M _{spec} [Ncm/cm]	P _{spec} [W/cm]
0	6,58	0,209	0,000
20	6,36	0,202	0,004
40	6,18	0,197	0,008
60	6,03	0,192	0,012
80	5,90	0,188	0,016
100	5,79	0,184	0,019
150	5,56	0,177	0,028
200	5,38	0,171	0,036
300	5,10	0,162	0,051
400	4,89	0,156	0,065
500	4,72	0,150	0,079
600	4,58	0,146	0,092
700	4,45	0,142	0,104
730	4,42	0,141	0,108
800	4,35	0,138	0,116
900	4,25	0,135	0,127
1000	4,16	0,132	0,139
1100	4,08	0,130	0,150
1200	4,01	0,128	0,160
1300	3,94	0,125	0,171
1400	3,88	0,124	0,181
1460	3,85	0,123	0,187
1500	3,82	0,122	0,191
1600	3,77	0,120	0,201
1700	3,72	0,118	0,211
1800	3,67	0,117	0,220
1900	3,62	0,115	0,229
2000	3,58	0,114	0,239
2200	3,50	0,111	0,257
2400	3,42	0,109	0,274

R.p.m. n [min ⁻¹]	F _{Uspec} [N/cm]	M _{spec} [Ncm/cm]	P _{spec} [W/cm]
2500	3,39	0,108	0,282
2600	3,35	0,107	0,290
2800	3,29	0,105	0,307
2880	3,26	0,104	0,313
3000	3,23	0,103	0,323
3200	3,17	0,101	0,338
3400	3,12	0,099	0,354
3600	3,07	0,098	0,368
3800	3,02	0,096	0,383
4000	2,98	0,095	0,397
4500	2,88	0,092	0,432
5000	2,78	0,088	0,463
5500	2,70	0,086	0,495
6000	2,63	0,084	0,526
6500	2,56	0,081	0,555
7000	2,49	0,079	0,581
7500	2,43	0,077	0,607
8000	2,37	0,075	0,632
8500	2,32	0,074	0,657
9000	2,27	0,072	0,681
9500	2,22	0,071	0,703
10000	2,18	0,069	0,727
12000	2,02	0,064	0,808
15000	1,82	0,058	0,910
18000	1,66	0,053	0,996
20000	1,57	0,050	1,047

Rotational speeds over 20000 rpm and/or belt speeds over 80 m/s need special drive designs. Please ask for our advice.

2. Tension member strength (permitted tensile force of the belt F_{zul}), Belt weight

Belt width	b	[mm]	4	6	10	16	25	32
Tension member strength F _{zul}	[N]		39	65	117	195	312	403
Belt weight	M	[kg/m]	0,005	0,007	0,012	0,019	0,030	0,038

3. Flexibility (Minimum numbers of teeth, minimum diameter)

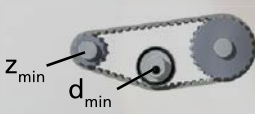
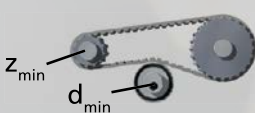
Timing pulley	Z _{min}		10		Drive type without contraflexure
Tension roller (smooth), running on teeth	d _{min}	[mm]	15		
Timing pulley	Z _{min}		18		Drive type with contraflexure
Tension roller (smooth), running on the back of the belt	d _{min}	[mm]	15		

Serrated Profile Timing Belts

K 1 / K 1,5

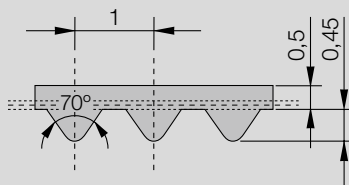

CONTI® SYNCHROFLEX Timing Belt (SFX) K 1

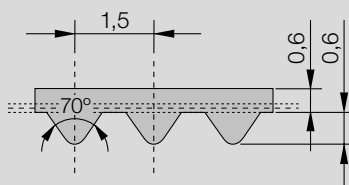

CONTI® SYNCHROFLEX Timing Belt (SFX) K 1,5

Serrated metric pitch profile.

The technical data refer to standard polyurethane and standard steel cord tension members.

Available versions:

- single-sided
- with Aramide tension member
- polyurethane special materials upon request
- antistatic, coloured, mechanical reworked

Type / Length*	Number of teeth
K 1 / 279,0	279
K 1 / 348,0	348
K 1,5 / 57,0**	38
K 1,5 / 64,5**	43
K 1,5 / 67,5**	45
K 1,5 / 100,5	67
K 1,5 / 141,0	94
K 1,5 / 165,0	110
K 1,5 / 201,0	134
K 1,5 / 228,0	152
K 1,5 / 286,0	191
K 1,5 / 300,0	200

Type / Length*	Number of teeth
K 1,5 / 400,5	267
K 1,5 / 501,0	334
K 1,5 / 600,0	400
K 1,5 / 1242,5	828
K 1,5 / 1671,5	1114

Preferred belt width* in mm:
4, 6, 10

* Other dimensions upon request.
** In casting polyurethane 93 ShA, red colour.

Order example

CONTI® SYNCHROFLEX Timing Belt 6 K1,5/100,5

Belt width in mm _____

Type/Pitch _____

Belt length in mm _____

K / K1,5 Technical data

1. Tooth shear strength (specific belt tooth strength)



R.p.m. n [min ⁻¹]	F _{Uspec} [N/cm]	M _{spec} [Ncm/cm]	P _{spec} [W/cm]	R.p.m. n [min ⁻¹]	F _{Uspec} [N/cm]	M _{spec} [Ncm/cm]	P _{spec} [W/cm]
0	6,45	0,154	0,000	2500	3,32	0,079	0,207
20	6,23	0,149	0,003	2600	3,29	0,079	0,214
40	6,06	0,145	0,006	2800	3,22	0,077	0,225
60	5,91	0,141	0,009	2880	3,20	0,076	0,230
80	5,79	0,138	0,012	3000	3,17	0,076	0,238
100	5,68	0,136	0,014	3200	3,11	0,074	0,249
150	5,46	0,130	0,020	3400	3,06	0,073	0,260
200	5,28	0,126	0,026	3600	3,01	0,072	0,271
300	5,00	0,119	0,037	3800	2,96	0,071	0,281
400	4,80	0,115	0,048	4000	2,92	0,070	0,292
500	4,63	0,111	0,058	4500	2,82	0,067	0,317
600	4,49	0,107	0,067	5000	2,73	0,065	0,341
700	4,37	0,104	0,076	5500	2,65	0,063	0,364
730	4,33	0,103	0,079	6000	2,57	0,061	0,385
800	4,26	0,102	0,085	6500	2,51	0,060	0,408
900	4,17	0,100	0,094	7000	2,44	0,058	0,427
1000	4,08	0,097	0,102	7500	2,38	0,057	0,446
1100	4,00	0,095	0,110	8000	2,33	0,056	0,466
1200	3,93	0,094	0,118	8500	2,27	0,054	0,482
1300	3,87	0,092	0,126	9000	2,22	0,053	0,499
1400	3,81	0,091	0,133	9500	2,18	0,052	0,518
1460	3,77	0,090	0,138	10000	2,13	0,051	0,532
1500	3,75	0,090	0,141	12000	1,98	0,047	0,594
1600	3,69	0,088	0,148	15000	1,78	0,042	0,667
1700	3,64	0,087	0,155	18000	1,63	0,039	0,733
1800	3,60	0,086	0,162	20000	1,54	0,037	0,770
1900	3,55	0,085	0,169				
2000	3,51	0,084	0,175				
2200	3,43	0,082	0,189				
2400	3,35	0,080	0,201				

Rotational speeds over 20000 rpm and/or belt speeds over 80 m/s need special drive designs. Please ask for our advice.

2. Tension member strength (permitted tensile force of the belt F_{zul}), Belt weight

Belt width	b	[mm]	4	6	10	16	25	32
Tension member strength F _{zul}		[N]	39	65	117	195	312	403
Belt weight	K 1	[kg/m]	0,0044	0,007	0,011	0,018	0,028	0,035
	K 1,5	[kg/m]	0,004	0,006	0,010	0,016	0,025	0,032

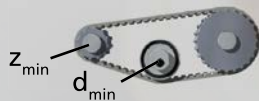
3. Flexibility (Minimum numbers of teeth, minimum diameter)

Timing pulley	z _{min}	14		Drive type without contraflexure
Tension roller (smooth), running on teeth	d _{min} [mm]	15		
Timing pulley	z _{min}	20		Drive type with contraflexure
Tension roller (smooth), running on the back of the belt	d _{min} [mm]	15		

F Flat Belts

F / AF / BF / CF / DF

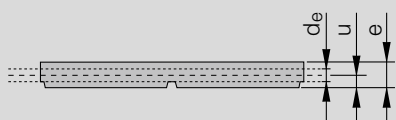
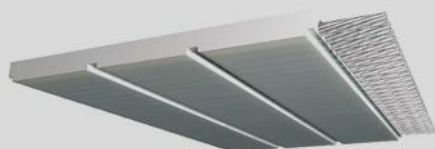

CONTI® SYNCHROFLEX Flat Belt (SFX)

The technical data refer to standard polyurethane and standard steel cord tension members.

Type	Mould Nr.	Length [mm]	e [mm]	u [mm]	d _e [mm]
F 213/7	K3969-Z	212,95	1,60	0,800	0,15
F 254/4	K5111-Z	253,74	0,80	0,400	0,15
F 314/5	K5558-Z	314,16	5,50	2,000	0,60
F 315/4	K5428-Z	315,73	1,20	0,600	0,15
F 330/2	K5651-Z	330,00	1,00	0,400	0,15
F 435/2	K5691-Z	435,00	0,80	0,400	0,15
F 502/7	K5430-Z	501,84	1,00	0,500	0,30
F 697/4	52648-Z	695,57	0,55	0,275	0,15
F 738/4	K5112-Z	738,64	0,80	0,400	0,15
F 762/7	K3708-Z	762,00	2,60	1,300	0,30
F 959/2	K5578-Z	959,40	1,00	0,500	0,30
F 1240/10	K5178-Z	1240,00	1,20	0,800	0,60
F 1458/9	K4377-Z	1458,50	2,60	0,450	0,30
F 1780/10	K4667-Z	1780,00	1,40	0,600	0,60
AF 24	51669-Z	113,08	0,80	0,275	0,15
AF 56	51772-Z	263,16	0,80	0,400	0,15
AF 67	51601-Z	315,70	0,70	0,275	0,15
AF 76	39669-Z	357,30	0,80	0,400	0,15
AF 87	38919-Z	409,57	0,85	0,575	0,15
AF 108	39796-Z	508,39	0,70	0,275	0,15
AF 138	39847-Z	649,60	0,80	0,275	0,15
AF 140	40121-Z	659,03	0,60	0,275	0,15
AF 148	39631-Z	695,57	0,80	0,275	0,15
BF 44	38852-Z	345,57	0,90	0,450	0,30
BF 64	38805-Z	501,85	0,90	0,450	0,30
BF 67	38902-Z	525,70	0,90	0,450	0,30
BF 70	39980-Z	548,90	0,90	0,450	0,30
CF 66	38917-Z	828,55	1,40	0,700	0,60
DF 45	39839-Z	282,74	0,90	0,450	0,30
DF 130	51636-Z	815,34	0,90	0,450	0,30
DF 153	39979-Z	959,40	0,90	0,450	0,30

Order example

CONTI® SYNCHROFLEX Flat Belt 10 AF/108

Belt width in mm _____
 Type/No. of grooves _____

Timing Belts with special tooth profiles

V (excerpts of XL, L, H)

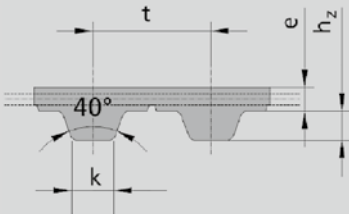

Type	Imperial pitch	Shape No.	Length l [mm]	Pitch t [mm]	Module m	Number of teeth		k [mm]	h _z [mm]	e [mm]
						z				
V 177/5	F	XL	K5841-F	177,80	5,080	1,617	35	1,20	1,20	0,85
V 203/5	F	XL	K5369-F	203,20	5,080	1,617	40	1,37	1,27	0,80
V 233/5	F	XL	K5674-F	233,68	5,080	1,617	46	1,37	1,22	1,28
V 284/5	F	XL	K5445-F	284,48	5,080	1,617	56	1,80	1,20	0,70
V 304/5	F	XL	K5368-F	304,80	5,080	1,617	60	1,37	1,27	0,60
V 381/5	F	XL	K6026-F	381,00	5,080	1,617	75	1,35	1,25	0,95
V 406/5	F	XL	K6064-F	406,40	5,080	1,617	80	1,37	1,27	1,30
V 508/5	F	XL	K6011-F	508,00	5,080	1,617	100	1,32	1,22	1,32
V 609/5	F	XL	K5546-F	609,60	5,080	1,617	120	1,36	1,20	0,70
V 635/5	F	XL	K5394-F	635,00	5,050	1,617	125	1,32	1,20	0,60
V 685/5	F	XL	K5821-F	685,80	9,538	1,617	135	1,62	1,20	0,70
V 889/5	F	XL	K5601-F	889,00	5,050	1,617	175	1,80	1,20	1,00
V 1097/5	F	XL	K5993-F	1097,28	5,080	1,617	216	1,37	1,27	1,30
V 1102/5	F	XL	K5776-F	1102,36	5,080	1,617	217	1,80	1,20	1,20
V 1178/5	F	XL	K5876-F	1178,56	5,080	1,617	232	1,80	1,20	1,00
V 1584/5	F	XL	K5600-F	1584,96	5,080	1,617	312	1,80	1,20	1,00
V 438/9	F	L	K5095-F	438,15	9,525	3,032	46	3,20	1,80	1,00
V 571/9	F	L	K6114-F	571,50	9,525	3,032	60	3,26	1,91	1,69
V 971/9	F	L	K5354-F	971,55	9,525	3,032	102	3,25	1,90	1,40
V 990/9	F	L	K5185-F	990,60	9,525	3,032	104	3,10	2,20	1,65
V 1000/9	F	L	K5202-F	1000,13	9,525	3,032	105	3,10	2,20	1,65
V 1028/9	F	L	K5589-F	1028,70	9,525	3,032	108	3,10	1,90	1,65
V 1104/9	F	L	K5435-F	1104,90	9,525	3,032	116	3,25	1,90	2,30
V 1152/9	F	L	K5493-F	1152,53	9,525	3,032	121	3,10	1,90	1,65
V 1257/9	F	L	K5310-F	1257,30	9,525	3,032	132	3,20	1,90	1,65
V 1390/9	F	L	K5449-F	1390,65	9,525	3,032	146	3,20	1,90	1,30
V 914/12	F	H	K5692-F	914,40	12,700	4,043	72	4,30	2,20	1,85
V 1270/12	F	H	K5258-F	1270,00	12,700	4,043	100	4,45	2,18	2,01
V 1778/12	F	H	K5260-F	1778,00	12,700	4,043	140	4,40	2,30	1,40

Order example

CONTI® SYNCHROFLEX Flat Belt 10 V 177 / 5 F

Belt width in mm

Type/Length

Coated timing belts

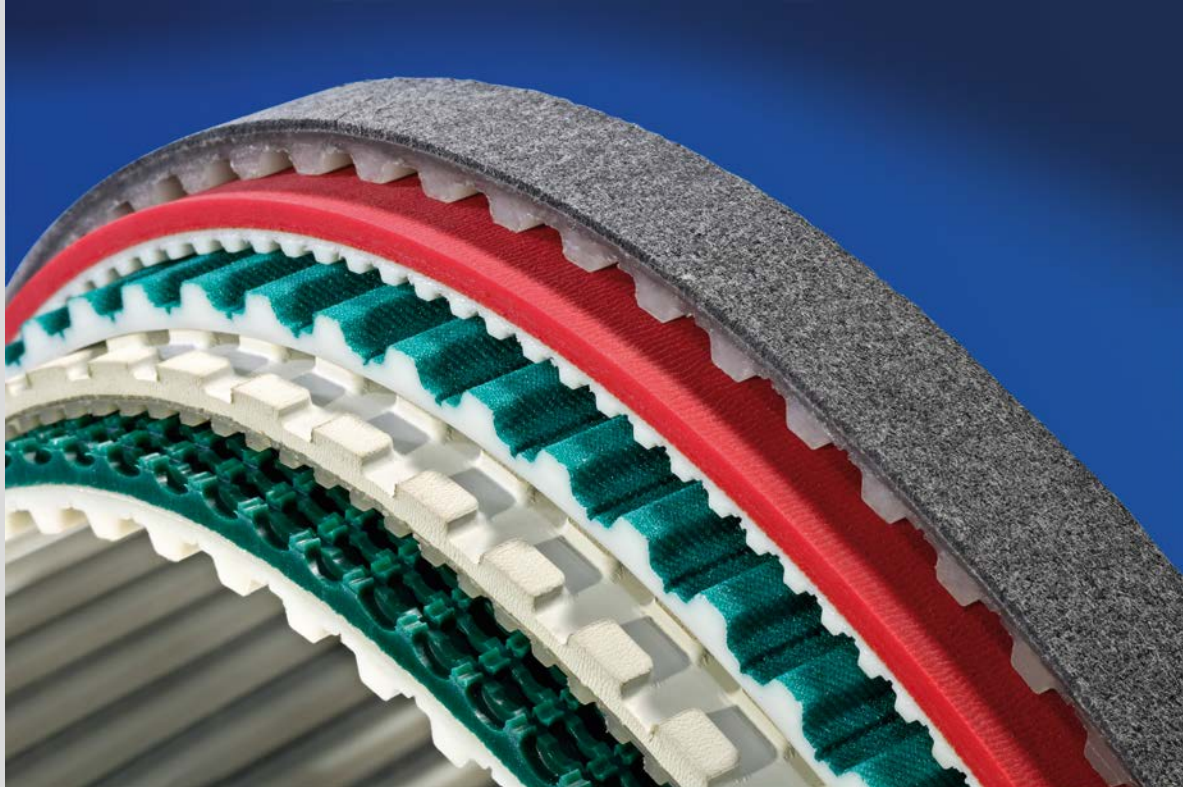

CONTI® SYNCHROFLEX timing belts consist of wear resistant polyurethane (PUR) and high tensile steel cord tension members. The coating of the timing belts with various materials provides a variety of application possibilities in the transport technology.

The selection of the correct coating depends on the transport item properties and the required grip. High friction for a good carrying effect, low friction to reduce the power transmission performance, soft for sensitive items or hard for sharp-edged items are the determining factors.

Every material involved assumes its task according to its specific property.

To meet specific transport applications, the tooth side and/or the transport side can be mechanically reworked. In this manner, the flexibility of the entire belt can be restored by making incisions in thick coatings.

Resistance

Depending on the application the resistance of each material part of the coated timing belt is to be viewed separately. The material resistance depends, among others, on the pH value, the concentration, the temperature and the influencing time of the medium. Simple oils generally have no damaging effect on the belt. Additives in the oil and temperatures over approx. 40°C can reduce the longevity.

Friction

The friction of the belt on a support produces heat. This increases the more the belt is loaded by the items to be transported. The bed support must be selected such that the friction value of the transport belt in contact with the material of the bed plate results in a minimum value. The bed plate should guarantee good heat dissipation under high pressure forces.

The friction value is temperature dependent. It increases as the temperature rises and reduces at temperatures below zero (frost).

Information

You should ask for advice for coatings over 75 mm wide and approx. 2 mm thick because of the different processing properties.

Drives with contraflexure

Generally, coated timing belts are suitable for drives with contraflexure. Very smooth coatings (e.g. Sylomer) must be adjusted with reduced pre-tension.

Temperature influence

If hot items (above approx. 80°C) are transported, ensure that the contact time is as short as possible to avoid heating of the belt substructure to over 80°C. A coated belt can resist a thermally higher load over short distances or a short period, assuming that there being sufficient cooling for the remainder of the revolution.

The tooth shear strength is slightly reduced in a temperature range of over approx. 60°C. An additional safety factor is only required with a high tooth load.

The flexibility of the coating is reduced with low ambient temperatures. To this effect, select larger timing pulley diameters compared to normal temperatures (see diagram). The flexibility of the timing belt is also reduced with low temperatures.

The stated minimum diameters are standard values. They are valid with the ambient temperature of 20°C and a speed of 1m/s. A low load of the goods to be transported is presumed. Reducing the diameters is possible with precise knowledge of the application. Relevant advice can be obtained from your Mulco partner.

Synchronising pulley diameter depending on the temperature

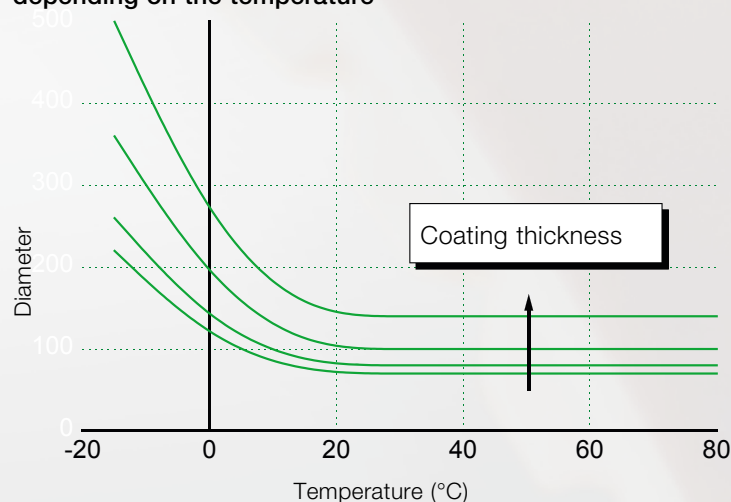

Coated timing belts

NP 385

Material designation: polyurethane
 Colour: transparent
 Hardness: 85 Shore A
 Available thickness: 4 mm
 Minimum diameter: 120 mm
 Temperature resistance: -20°C to +50°C
 Resistances: resistant against simple oils and fats
 Properties: nub tip contact with the product to be transported
 Application fields: transport with oil influence, sheet transport, elevator, brick making, glass industry



FG 385

Material designation: polyurethane
 Colour: transparent
 Hardness: 85 Shore A
 Available thickness: 4 mm
 Minimum diameter: 120 mm
 Temperature resistance: -20°C to +50°C
 Resistances: resistant against simple oils and fats
 Properties: linear contact of the product to be transported
 Application fields: transport with oil influence, sheet transport, elevator, brick making, glass industry

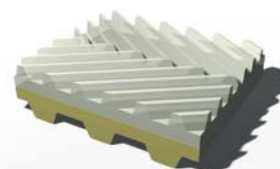

PUR 385

Material designation: polyurethane
 Colour: transparent
 Hardness: 85 Shore A
 Available thickness: 3 4 5 6 mm
 Minimum diameter: 80 120 150 180 mm
 Temperature resistance: -20°C to +50°C
 Resistances: resistant to petrol, ozone, simple fats and oils
 Properties: high resistance to wear, high coefficient of friction
 Application fields: transport of parts showing a coarse surface or burrs, woodworking and sheet fabricating industry, glass industry, cardboard transport

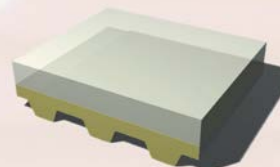

HV1 film

Material designation:	polyurethane
Colour:	transparent, shiny
Hardness:	88 Shore A
Available thickness:	1 mm
Minimum diameter:	60 mm
Melting range:	approx. 166°C
Resistances:	resistant to some cleaning agents
Properties:	good wear resistance, adhesive
Application fields:	foodstuff industry, glass and woodworking industry, sheet fabricating industry, cardboard transport

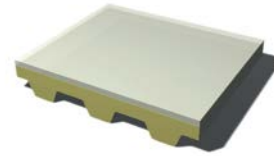
**Polythane D15**

Material designation:	polyurethane
Colour:	transparent/yellowish
Hardness:	70 Shore A
Available thickness:	2 3 to 6 mm
Minimum diameter:	60 80 mm
Temperature resistance:	80°C
Resistances:	resistant against simple oils and fats
Properties:	wear resistant
Application fields:	general transport tasks, woodworking and glass industry, sheet fabricating industry

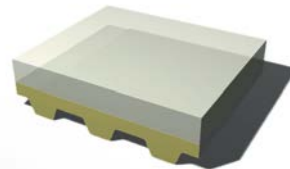
**Compound coating**

Material designation:	e.g. PUR/silicone
Colour:	white
Hardness:	60 / 50 Shore A
Available thickness:	2.4 mm
Minimum diameter:	60 mm
Temperature resistance:	in accordance with the materials used, Silicone: short-term 180°C
Resistances:	in accordance with the materials used
Properties:	non-stick
Application fields:	light weight transport tasks, air filter transport, textile and wood industry

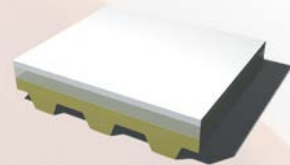
**PVC white**

Material designation:	PVC
Colour:	white
Hardness:	approx. 40 Shore A
Available thickness:	2 mm (more thicknesses on request)
Minimum diameter:	60 mm
Temperature resistance:	-15°C to +90°C
Resistances:	top covering layer is resistant against acid, salts and bases
Properties:	FDA approval for contact with foodstuff
Application fields:	foodstuff industry, film processing, pharmaceutical and packaging industry

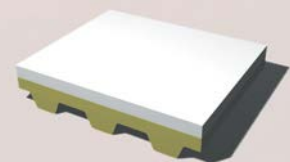

Coated timing belts

PU yellow

Material designation: polyurethane
 Colour: yellow
 Hardness: approx. 55 ± 7 Shore A
 Available thickness: 2 3 4 5 6 8 10 mm
 Minimum diameter: 60 60 80 100 100 100 20 mm
 Temperature resistance: -10°C to +60°C
 Resistances: resistant against simple oils and fats
 Properties: good wear resistance, very good to rework
 Application fields: vacuum transport belts subject to high loads, paper industry, textile industry, glass and wood industry

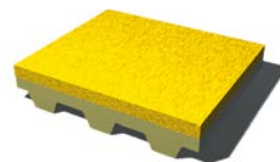

Porol

Material designation: cellular rubber
 Colour: black
 Density, hardness: 190 g/dm³, approx. 15 Shore A
 Available thickness: 3 5 10 mm
 Minimum diameter: 40 60 80 mm
 Temperature resistance: -40°C to +70°C
 Resistances: resistance to some simple fats and oils
 Properties: smooth foam quality, high coefficient of friction
 Application fields: transport of sensitive parts, paper industry, textile industry, cardboard transport

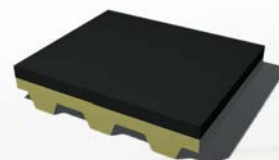

Celloflex

Material designation: microcellular elastomeric polyurethane
 Colour: yellow-brown
 Density: 350 g/dm³
 Available thickness: 1 2 3 4 5 mm
 Minimum diameter: 40 40 60 60 80 mm
 Temperature resistance: -30°C to +80°C
 Resistances: resistance to some simple fats and oils
 Properties: highly flexible, high damping ratio
 Application fields: transport of sensitive items, film and packaging industry, textile transport

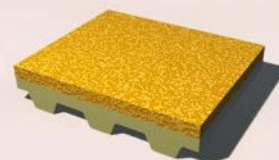

Linatex

Material designation: natural rubber
 Colour: red
 Hardness: approx. 40 Shore A
 Available thickness: 1.5 2.4 3 5 6.4 8 10 12 20 mm
 Minimum diameter: 40 60 80 80 100 100 120 120 150 mm
 Temperature resistance: -40°C to +70°C
 Resistances: resistant to some oils and abrasion when wet
 Properties: wear resistant to a limited extent, high coefficient of friction, high resistance to rupture, is still flexible at lower temperatures, please request for advice for coating thicknesses over 2.4 mm
 Application fields: transport or haul-off belts subject to high friction, wood, paper, textile industry, transport with a high acceleration

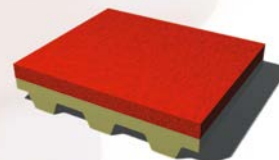

Sylomer

Material designation:	Elastomeric PUR		
Colour:	Blue (R)	Green (L)	Brown (M)
Density:	220	300	400 g/dm ³
Available thickness:	3-25	3-25	3-25 mm
Minimum diameter:	80 - 120	80 - 120	80 - 120 mm
Temperature resistance:	-30°C to +70°C		
Resistances:	resistance to some oils and fats		
Properties:	good wear resistance, not suitable for sharpedged items		
Application fields:	transport of light weight parts, paper and textile industry, haul-off belts, pressure belts		

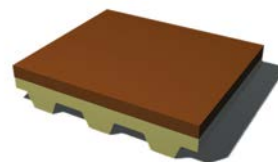
**PVC blue**

Material designation:	PVC
Colour:	blue
Hardness:	approx. 40 Shore A
Available thickness:	1 mm
Minimum diameter:	30 mm
Temperature resistance:	-15°C to +90°C
Resistances:	top covering layer is resistant against acid, salts and bases
Properties:	high coefficient of friction
Application fields:	paper, film, wood and sheet transport, pharmaceutic and packaging industry, application in card reading units

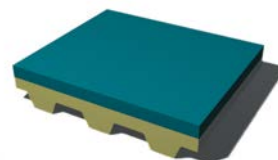
**Chrome-leather**

Material designation:	leather
Colour:	grey-blue
Hardness:	-
Available thickness:	2 3 mm
Minimum diameter:	80 100 mm
Temperature resistance:	60°C
Resistances:	resistant against simple oils and fats
Properties:	good friction even with oiled surfaces of items to be transported, good wear resistance behaviour
Application fields:	transport of fatty or oily parts, sheet and tube industry, transport of sensitive products, caterpillar haul-offs in the cable industry, transport of lacquered parts

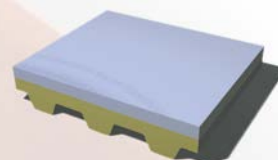
**Correx**

Material designation:	para rubber
Colour:	brown
Hardness:	approx. 35 to 40 shore A
Available thickness:	6 10 mm
Minimum diameter:	80 120 mm
Temperature resistance:	up to approx. 70°C
Resistances:	resistant to some oils and fats
Properties:	wear resistant quality, good carrying behaviour
Application fields:	general transport tasks, sheet and tube transport, cardboard transport

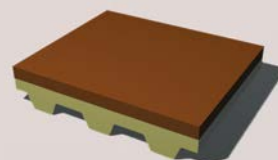

Coated timing belts

PVC herringbone

Material designation: PVC
 Colour: white
 Hardness: approx. 65 Shore A
 Available thickness: 3 mm
 Minimum diameter: 60 mm
 Temperature resistance: -10°C to +110°C
 Resistances: resistant to some oils and fats
 Properties: FDA approval for contact with foodstuff
 Application fields: foodstuff industry, elevators, transport of glass in wet areas

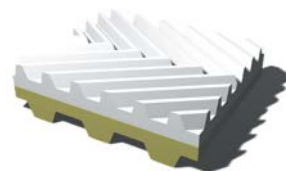

Viton

Material designation: FKM mix
 Colour: black
 Hardness: 75 ± 5 Shore A
 Available thickness: 2 4 mm
 Minimum diameter: 80 100 mm
 Temperature resistance: -10°C to +275°C
 Resistances: high heat resistance, resistant against simple oils and fats, petrol, acids, lyes, ozone
 Application fields: short-term transport of parts with high residual heat, belts with glue and adhesive contact, metal part and glass transport

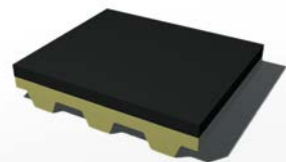

Linatrilite

Material designation: vulcanized material based on nitrile
 Colour: orange
 Hardness: 55 Shore A
 Available thickness: 3-6 mm (more thicknesses on request, max. 25 mm)
 Minimum diameter: depending on the selected thickness, the thicker the coating the larger the diameter must be selected
 Temperature resistance: -20°C to +110°C
 Resistances: resistant against oil, fat and other chemicals
 Properties: good wear resistance, ageing stability, fatigue resisting
 Application fields: haul-off belts in the textile area, transport of waxy materials

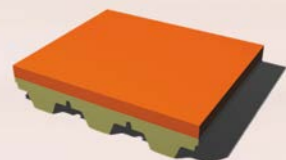

Supergrip green/blue

Material designation:	PVC	
Colour:	green	blue
Hardness:	approx. 40 Shore A	approx. 40 Shore A
Available thickness:	4 mm	4 mm
Minimum diameter:	60 mm	60 mm
Temperature resistance:	-15°C to +90°C	-15°C to + 90°C
Resistances:	resistant against simple oils and fats	not resistant to oil
Properties:	high resistance to wear, high coefficient of friction	
Application fields:	particularly suitable for inclined conveying, transport of light weight items, elevators in the wood and paper industry	

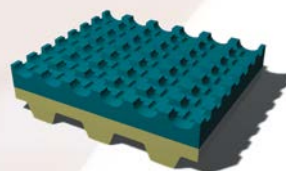

RP 400

Material designation:	rubber
Colour:	yellow
Hardness:	35 Shore A
Available thickness:	2 3 4 5 6 mm (more thicknesses on request, max. 30 mm)
Minimum diameter:	30 40 40 60 60 mm
Temperature resistance:	-10°C to +80°C
Resistances:	resistant to some oils and fats
Properties:	very high resistance against wear and tear
Application fields:	glass and steel industry, abrasive material up to a size of 40 mm

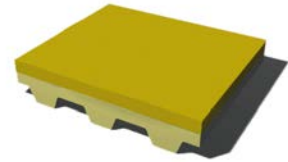
**NBR**

Material designation:	Nitrile Butadiene Rubber
Colour:	black
Hardness:	65 ± 5 Shore A
Available thickness:	1,5 3 mm
Minimum diameter:	60 80 mm
Temperature resistance:	-20°C to +70°C
Resistances:	well resistant against oils, resistant to a limit extent against petrol, acid and alkalis
Application fields:	general transport tasks

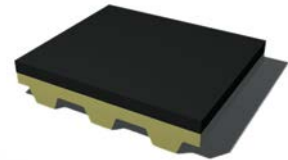
**PVC Minigrip**

Material designation:	PVC
Colour:	green/blue
Hardness:	approx. 65 Shore A
Available thickness:	1,5 mm
Minimum diameter:	30 mm
Temperature resistance:	-10°C to +110°C
Resistances:	resistant to some oils and fats
Properties:	high coefficient of friction
Application fields:	transport of damp parts, good carrying behaviour due to profiled surface

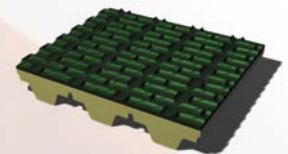
**TT 60**

Material designation:	polyester fleece
Colour:	black
Available thickness:	2 mm
Minimum diameter:	120 mm
Temperature resistance:	-10°C to +120°C
Resistances:	resistance to oils and fats
Properties:	electro-static properties
Application fields:	glass industry as transport belt in the hot area

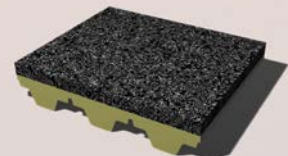

Integrated flights

CONTI® SYNCHROFLEX Timing Belts with cast flights/profiles:

CONTI® SYNCHROFLEX timing belts with profiles offer further opportunities for the designer with flights or cleats on the belt back. Can be used in conveying, feeding or positioning.

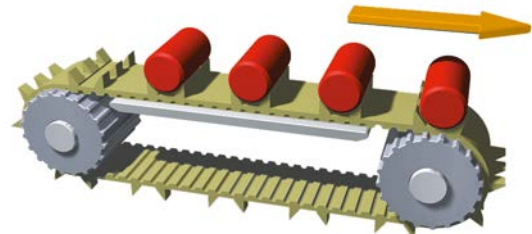

Assembly belt

Maximum precision is achieved by the manufacture in one operating step using a timing belt mould. Customer requirements with regard to the shape of the flights and

their number can be taken into consideration at the time of producing a new mould. Best flight centre distance tolerance achievable: +/- 0.05 mm.

Examples of flighted CONTI® SYNCHROFLEX timing belts from a single mould:

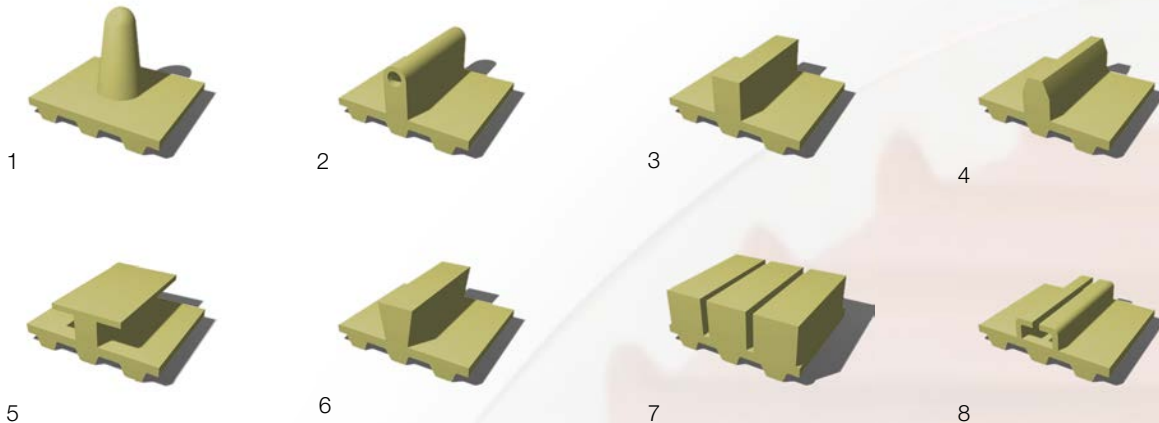

Application example

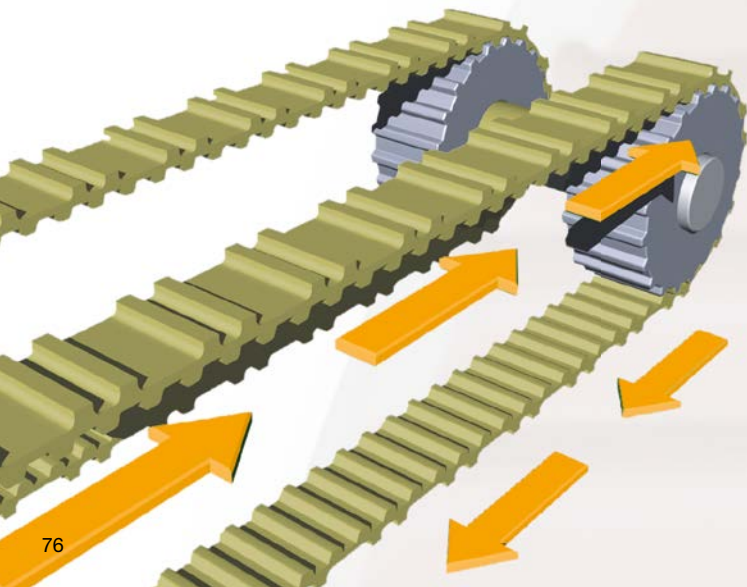

Applications:

Synchronising technology to achieve maximum precision

- EDP equipment
- Office machinery
- Fine mechanical technology
- Packaging machinery
- Indexing systems
- Synchronous conveyors
- Handling technology
- Transport technology

Please contact us for technical advice if you require more detailed information on special belt dimensions (existing timing belt moulds).

CONTI® SYNCHROFLEX timing belts with welded flights/profiles:

All CONTI® SYNCHROFLEX timing belts as from pitch T 2.5 can be retrofitted with flights. In line with the customer's drawing, the desired number of flights are thermally butt-welded to the back of the belt. The achieve-

vable weld-on tolerance of each individual flight is ± 0.5 mm. Hundreds of shapes of flights are available. Please ask for additional information. For special customer requirements new flights can be manufactured.

Examples of possible flight shapes requiring mechanical re-work:

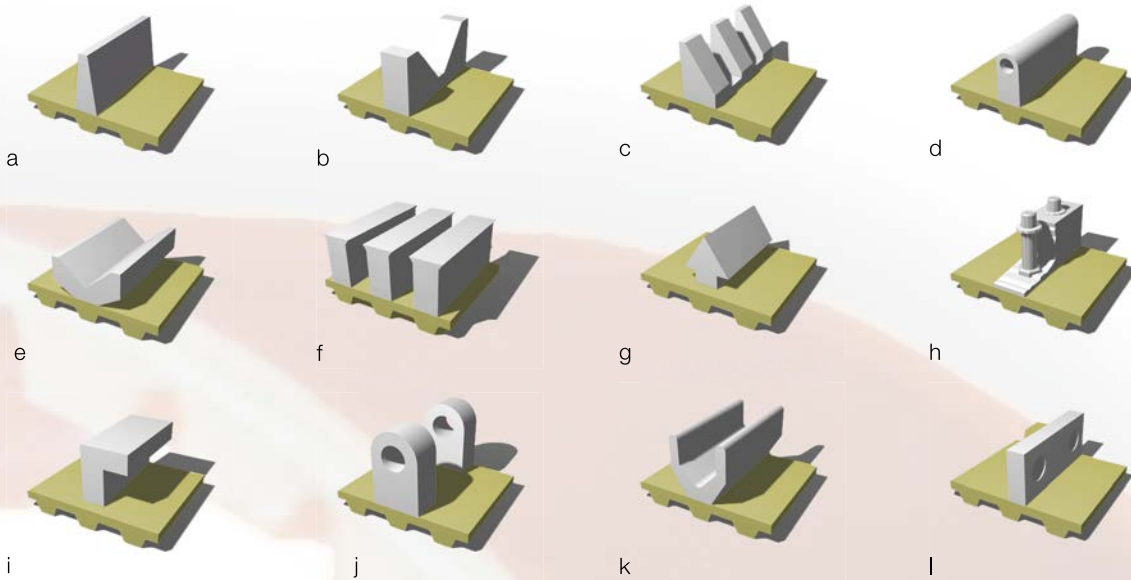

The various shapes of flights allow an adaptation of the transport timing belt to the envisaged practical function. The flight pitch is freely selectable. The flights can be manufactured with moulded inserts. Profile attachments can be retrofitted (positioned). The welding point itself and the maximum bending stress are subject to special parameters.

Please contact us for technical advice.

Applications:

General transport technology

- Conveying/transporting
- Separation
- Positioning
- Indexing
- Feeding

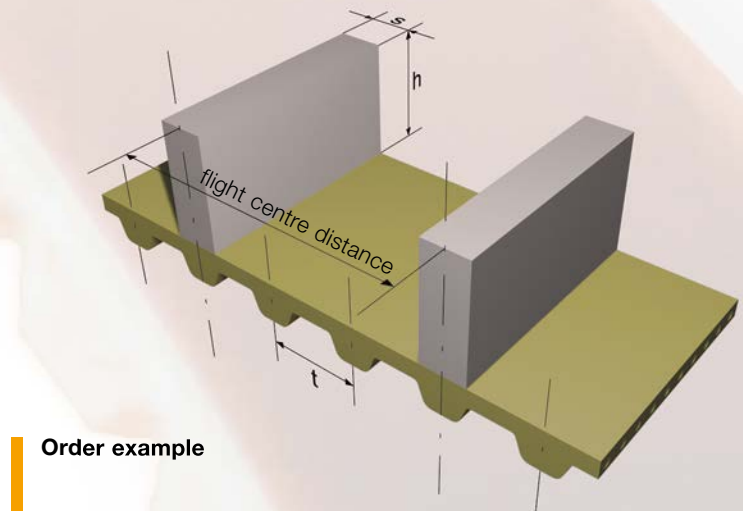

Order example

CONTI® SYNCHROFLEX Timing Belt	25 T 10 / 1960 - FN 49
Belt width in mm	_____
Type/Pitch	_____
Belt length in mm	_____
Number of profiles	_____

Brush timing belts

A solution for almost every application

To complement standard applications in power transmission, linear and transport technology, we offer the CONTI® SYNCHROFLEX brush timing belt for special applications.

Construction

The timing belt is either equipped with a stronger back with brush or - to meet the individual application - with brush flights. The thickness of the back is between 10 and 20 mm, depending on the fibre thickness and cutting length. Flight centre-distance, fibre density and type are individual matched to each application.

1. Timing belts with reinforced back (the necessary flexibility is achieved by notches in the back of the belt).
2. Brushes/fibres
3. Standard timing belt
4. Profile

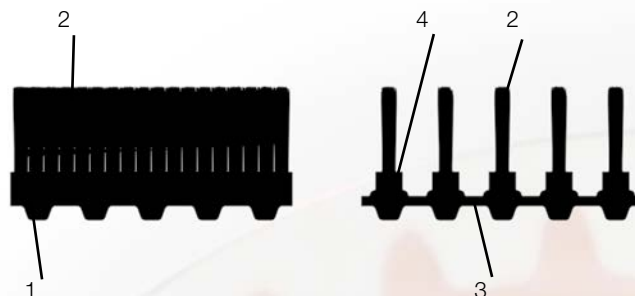

Versatile application

Conveying:

- Transport of sensitive parts for example: glass, ceramics, paper
- Conveying of materials featuring delicate surfaces
- Accumulation conveying due to the extremely low coefficient of friction
- Larger contact surface resulting from the fanned fibre arrangement
- Reduced conveying noise
- Dirt and chips cannot accumulate on the contact surface
- Combination with all transport flights

Cleaning:

- Dry and wet application
- Surface treatment

Product range

Brush timing belts are available in any length offered in our product range and in the following pitches:

T 5, T 10, T 20, AT 5, AT 10, AT 20

Please contact us for more detailed information on fibre materials, data on chemical resistances and admissible temperature ranges.

Natural fibres and hair

(max. cutting length 30 mm)

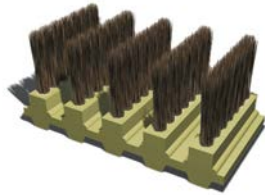

Horsehair, soft

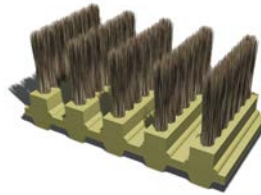

Horsehair mix, semi-hard

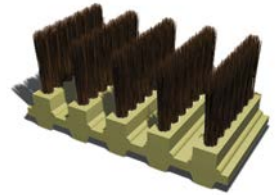
Calcutta bristles,
semi-hard**Plant fibres**

(cutting length 10 to 75 mm)

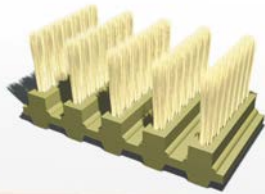

Mex. fibre, semi-hard

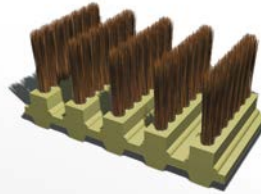

Arenga, hard

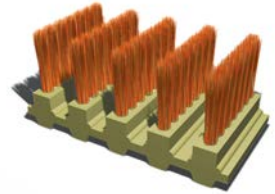

Coconut fibre, hard

Artificial bristles

(any cutting length)

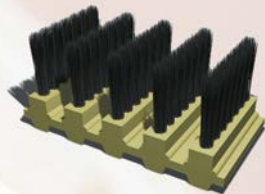

Mypren 0.20 mm dia.

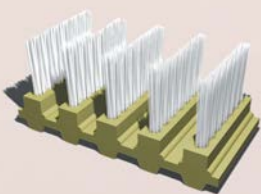
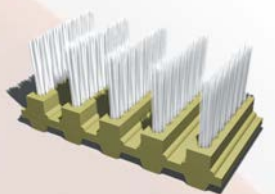
Nylon 6 Ø 0.15 to 0.5 mm
straight or corrugatedNylon 6.6.
Ø 0.15 - 0.5 mm
straight or corrugated**Wire**

(any cutting length)

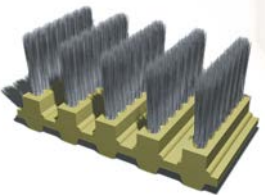
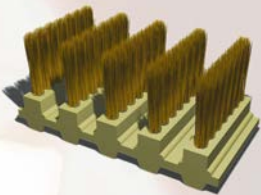
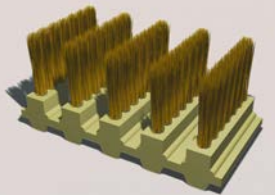
Steel wire
Ø 0.15 - 0,4 mm
straight or corrugatedBrass wire
Ø 0,1 - 0,4 mm
straight or corrugatedPhosphate bronze
Ø 0,1 - 0,4 mm
straight or corrugated

Mechanical rework

CONTI® SYNCHROFLEX timing belts can be mechanically reworked to meet special functional features. Timing belts with a thick backing are especially suited for mechanical rework. They offer far reaching design possibilities for the designer.

Available types: Version FA and coatings/coverings
Please note that the flexibility of timing belts with a thicker back is reduced and therefore, requiring larger pulley diameters. Belt flexibility can be improved by cross grooving or incisions.

Back cross milling

Cross grooves on the belt back enhance the flexibility of the belt. Milled grooves are, in as much as they are possible from the technical feasibility point of view, used to improve safe loading and secure positioning of the products on the belts.



Back longitudinal milling

Independent on the belt pitch, the belt back shaping offers a wide range of design variants for customised solutions. In this manner, belt guiding can be achieved by a trapezoidal back profile, or a round section supported and moved by means of a prism shaped cross section. Dimensions are to be indicated as depth measure x in relation to the belt back.

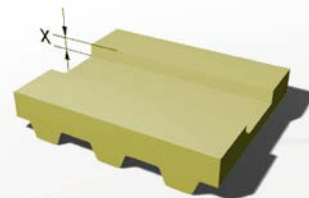

Back grinding

All CONTI® SYNCHROFLEX timing belts can be ground and finished for reasons of precision or in order to obtain a roughened surface. Note that the belts must not be ground to anything less than the overall thickness x because otherwise the tension members might take damage.

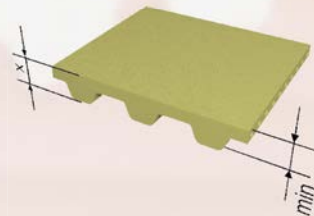

Edge grinding

Particularly accurate belt width tolerances can be achieved by grinding the belt edges.

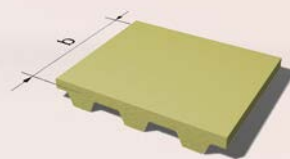

Removing individual teeth

The removal of individual teeth or groups of teeth is possible and practical due to the high dimensional precision meshing, when the remaining teeth are to serve as precise position load areas.

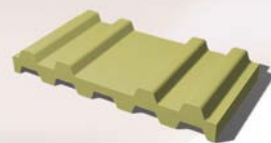

Longitudinal milling of teeth

Machining the tooth profile is significant for CONTI® SYNCHROFLEX timing belts which are protected from running off laterally for instance by bed plates. The processing depth x is indicated as measured from the tooth top surface.

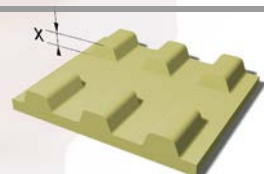

Perforated timing belts

Aramide tension members should be preferably used with CONTI® SYNCHROFLEX timing belts in this type of application.



List of Catalogues

All our information at a glance

Polyurethane Timing Belts

BRECO®, BRECOFLEX® timing belts
 BRECO®, BRECOFLEX® – Processing of timing belts
 BRECO®, BRECOFLEX® flat belts
 BRECO® ATN-system
 BRECOprotect® – Timing Belts
 BRECObasic® – Timing Belts

CONTI® SYNCHROFLEX Polyurethane Timing Belts. Overall catalog
 CONTI® SYNCHROCHAIN / SYNCHROCHAIN CARBON Heavy-Duty Timing Belts
 CONTI® SYNCHRODRIVE Polyurethane Synchronous Drive Belts
 CONTI® SYNCHRODRIVE N10 Nubbed Belt
 CONTI® POLYFLAT PU Flat Belts

Pulleys and Accessories

PULLEYS & COMPONENTS for polyurethane timing belt drives
 Portable TSG 4 welder for polyurethane timing belts

**All product information
 can be requested from
 your Mulco Partner.**

**New information material
 available for download at
www.mulco.net**

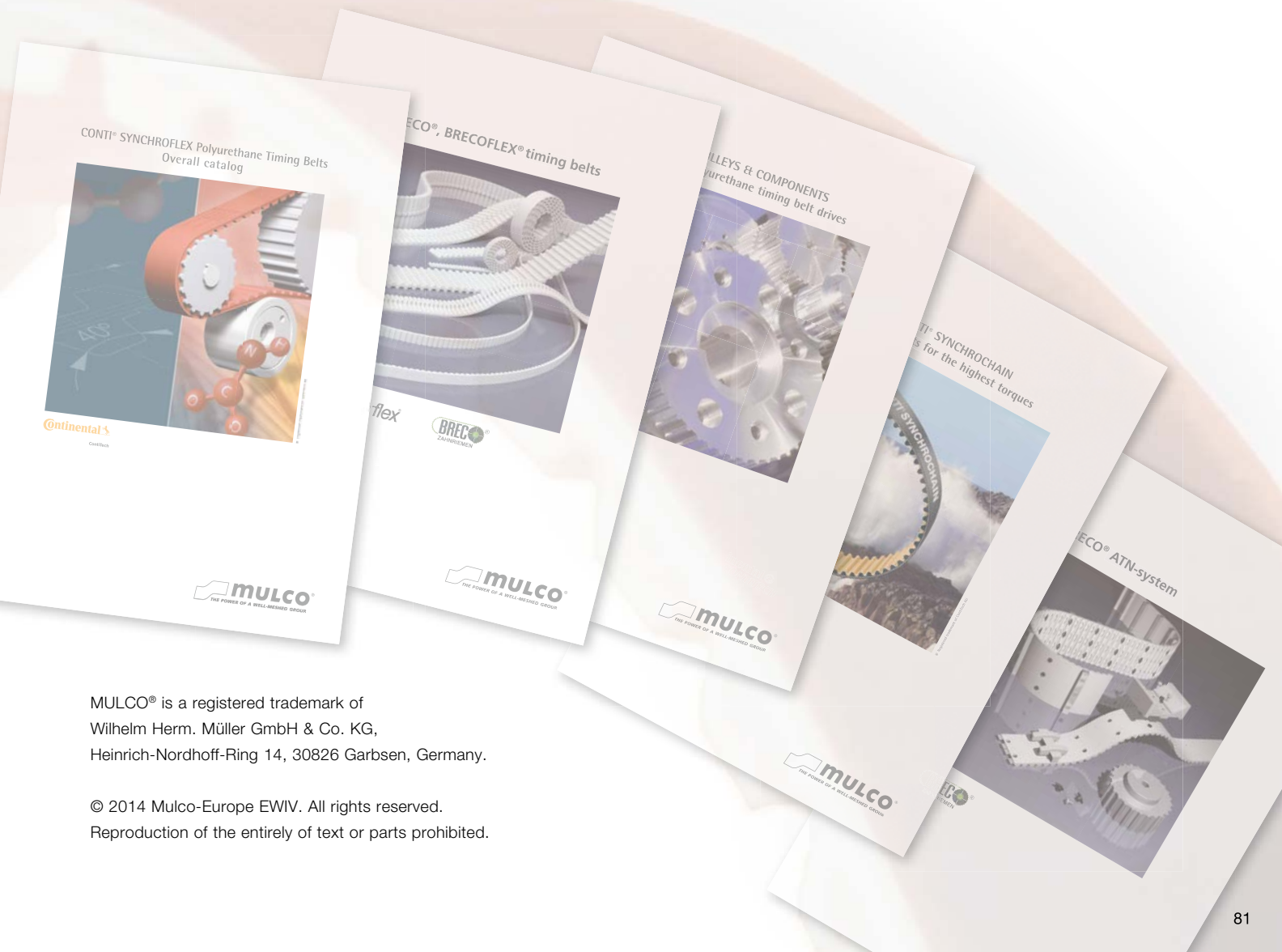

MULCO® is a registered trademark of
 Wilhelm Herm. Müller GmbH & Co. KG,
 Heinrich-Nordhoff-Ring 14, 30826 Garbsen, Germany.

© 2014 Mulco-Europe EWIV. All rights reserved.
 Reproduction of the entirety of text or parts prohibited.



ContiTech



Sales partners Germany

Hilger u. Kern Antriebstechnik

Hilger u. Kern GmbH
Antriebstechnik
Käfertaler Straße 253
68167 Mannheim
Phone: +49 621 3705-0
Fax: +49 621 3705-403
e-mail: antriebstechnik@hilger-kern.de
www.hilger-kern.com



Wilhelm Herm. Müller GmbH & Co. KG
Heinrich-Nordhoff-Ring 14
30826 Garbsen
Phone: +49 5131 4522-0
Fax: +49 5131 4522-110
e-mail: info@whm.net
www.whm.net



Roth GmbH & Co. KG
Andernacher Straße 14
90411 Nürnberg
Phone: +49 911 99521-0
Fax: +49 911 99521-70
e-mail: info@roth-ing.de
www.roth-ing.de



Anton Klocke Antriebstechnik GmbH
Senner Straße 151
33659 Bielefeld
Phone: + 49 521 95005-01
Fax: + 49 521 95005-11
e-mail: info@klocke-antrieb.de
www.klocke-antrieb.de



REIFF Technische Produkte GmbH
Tübinger Straße 2-6
72762 Reutlingen
Phone: +49 7121 323-0
Fax: +49 7121 323-318
e-mail: zahnriemen@reiff-gruppe.de
www.reiff-tp.de



Walter Rothermundt GmbH & Co. KG
Am Tannenbaum 2
41066 Mönchengladbach
Phone: +49 2161 694620
Fax: +49 2161 664469
e-mail: info@rothermundt.de
www.rothermundt.de

Sales partner France



BINDER MAGNETIC
1, Allée des Barbanniers
92632 Gennevilliers Cedex
France
Phone: +33 1 461380-80
Fax: +33 1 461380-99
e-mail: info@binder-magnetic.fr
www.binder-magnetic.fr

Sales partner Sweden



Aratron AB
Smidesvägen 4 – 8
171 41 Solna
Sweden
Phone: +46 8 4041-600
Fax: +46 8 984281
e-mail: info@aratron.se
www.aratron.se

Sales partner Austria



Haberkorn GmbH
Modecenterstraße 7
1030 Wien
Austria
Phone: +43 1 74074-0
Fax: +43 1 74074-99
e-mail: antriebselemente@haberkorn.com
www.haberkorn.com

Sales partner Great Britain



Transmission Developments Co. (GB) Ltd
Dawkins Road
Poole, Dorset, BH15 4HF
Great Britain
Phone: +44 1202 675555
Fax: +44 1202 677466
e-mail: sales@transdev.co.uk
www.transdev.co.uk

Sales partner Spain



Dinámica Distribuciones S.A.
Ctra. N. II, km 592,6
08740 S. Andreu de la Barca
Spain
Phone: +34 93 6533-500
Fax: +34 93 6533-508
e-mail: dinamica@dinamica.net
www.dinamica.net

Do you need further information on the Mulco product range? Please contact us.

Mulco-Europe EWIV, Phone: +49 5131 4522-0, Fax: +49 5131 4522-110, e-mail: info@mulco.net, www.mulco.net

